



**Michigan
Technological
University**

Michigan Technological University
Digital Commons @ Michigan Tech

Dissertations, Master's Theses and Master's Reports

2017

USING REMOTE SITE INCUBATORS FOR RE-INTRODUCTION OF ARCTIC GRAYLING (THYMALLUS ARCTICUS) TO THE BIG MANISTEE WATERSHED

Sunflower Wilson

Michigan Technological University, aswilson@mtu.edu

Copyright 2017 Sunflower Wilson

Recommended Citation

Wilson, Sunflower, "USING REMOTE SITE INCUBATORS FOR RE-INTRODUCTION OF ARCTIC GRAYLING (THYMALLUS ARCTICUS) TO THE BIG MANISTEE WATERSHED", Open Access Master's Thesis, Michigan Technological University, 2017.

<https://doi.org/10.37099/mtu.dc.etr/391>

Follow this and additional works at: <https://digitalcommons.mtu.edu/etr>



Part of the [Aquaculture and Fisheries Commons](#), [Biodiversity Commons](#), [Developmental Biology Commons](#), and the [Natural Resources and Conservation Commons](#)

USING REMOTE SITE INCUBATORS FOR RE-INTRODUCTION OF ARCTIC
GRAYLING (*THYMALLUS ARCTICUS*) TO THE BIG MANISTEE WATERSHED

By

Alicia Sunflower Wilson

A THESIS

Submitted in partial fulfillment of the requirements for the degree of

MASTER OF SCIENCE

In Biological Sciences

MICHIGAN TECHNOLOGICAL UNIVERSITY

2017

©2017 Alicia Sunflower Wilson

This thesis has been approved in partial fulfillment of the requirements for the Degree of MASTER OF SCIENCE in Biological Sciences.

Department of Biological Sciences

Thesis Advisor: *Dr. Nancy A. Auer*

Committee Member: *Dr. Robert E. Froese*

Committee Member: *Dr. Ebenezer Tumban*

Committee Member: *Mr. Daniel Mays*

Committee Member: *Dr. J. Marty Holtgren*

Committee Member: *Dr. Stephanie A. Ogren*

Department Chair: *Dr. Chandrashekar R. Joshi*

Table of Contents

List of Figures	vi
List of Tables	vii
Preface	viii
Acknowledgements	ix
Abstract	x
1. Introduction	1
2. Methods	4
2.1 Rainbow Trout	6
2.2 Brook Trout	6
2.3 Arctic Grayling	7
2.3 Data Analysis	7
3. Results	8
3.1 Rainbow Trout	8
3.2 Brook Trout	8
3.3 Arctic Grayling	9
4. Discussion	10
5. Conclusion	12
Figures and Tables	14
References	21

List of Figures

Figure 1. Illustration of Remote Site Incubator used in laboratory tests using three species of salmonids 2015-2016.

Figure 2. Estimated Rainbow Trout, Brook Trout and Arctic Grayling egg survival to hatch and survival to swim-up, 2015-2016.

Figure 3. Ratio of depth of the yolk sac to total length of the larval fish by date of hatch or swim – up and average daily water temperature, 2015-2016.

Figure 4. Average depth of the yolk sac compared to the total length of the larval Arctic Grayling.

Figure 5. Average water temperatures in Montana field studies during Arctic Grayling hatch compared to those in MTU laboratory and expected Manistee spring water temperatures

List of Tables

Table 1. Comparison of egg size, incubation time and temperature for three salmonid species as found in literature.

Table 2. Typical abiotic characteristics known for three salmonid species tested in RSI units 2015 and 2016.

Table 3. Egg densities used during RSI testing 2015 – 2016 for three salmonid species.

Table 4. RSI testing with Rainbow Trout eggs April 2015 to June 2015. Egg densities were 1600, 1200 and 800 per RSI unit.

Table 5. Results of duration to hatch for each species used in RSI testing 2015-2016

Table 6. Results of duration to hatch and swim-up and percent at each density for the salmonid species used in RSI testing in 2015 – 2016.

Preface

This thesis has been written as an article, which will be submitted for publication in scientific journals. For all aspects of the research (study design, data collection, laboratory analysis, data analysis, and interpretation and am the primary author. This thesis was written in collaboration with Dr. Nancy A. Auer and she contributed to the study design, acquisition of funding, grant administrator, data analysis and writing of the manuscript.

Acknowledgements

I would like to express my sincere appreciation and gratitude to my advisor Dr. Nancy A. Auer, for her guidance, mentorship and knowledge that she has so selflessly provided me. She has helped me grow in not only my professional and academic career but as a woman in science. I would not have made it to this point if not for her and I am truly fortunate for the opportunity to work with her.

I would like to thank my committee members, Dr. Ebenezer Tumban and Dr. Robert Froese for their helpful suggestions, guidance and explanation of complex topics. I would also like to thank Dr. Marty Holtgren and Dr. Stephanie Ogren for their mentorship throughout my life that helped me start the path into fisheries and encouragement to keep growing intellectually and professionally.

I would like to thank the Little River Band of Ottawa Indians Natural Resource department for their funding for this research.

Finally, I would like to acknowledge my family for their continued support; Cameron Goble for helping at numerous turns during my years here and my friends Rob Zupko II, James Mertens, Elizabeth Van Heusden, Brian Doughty, Marie Richards and many others in helping me become a better writer, scientist, graduate student and supporting me though the many hardships that I faced obtaining this degree.

Abstract

Remote Site Incubators (RSIs) were developed for the incubation of salmonid eggs directly at a field site to enhance success and imprinting of young. These have been employed in the re-establishment of Arctic Grayling in Montana and are being laboratory tested for possible reintroduction of this species in the Big Manistee River, MI. Arctic Grayling, Rainbow and Brook Trout eggs, obtained from state hatcheries, were reared in a laboratory using flow through lake water to assess egg and fry survival using RSIs. Dead eggs and fry were removed daily and observations of developmental stages recorded. Rainbow Trout eggs were evaluated at high, medium, and low egg densities with an average percent survival at hatch of 86% and swim-up of 72%. Brook Trout eggs were evaluated at medium and low densities has an average percent survival at hatch of 74% and swim-up 42%. In Montana, RSIs achieved success with 67% survival of Arctic Grayling eyed eggs to swim-up, and in this study hatch and swim-up for both medium and high density eyed-eggs was 54% and 77% respectively. This suggests that RSIs will be valuable tools future reintroductions to suitable Michigan streams.

1. Introduction¹

With the goal of restoring natural resources of cultural and spiritual significance to the tribe in 2011 the Little River Band of Ottawa Indians received funding to begin feasibility studies for future restoration of historically native Arctic Grayling (*Thymallus arcticus*) in the Big Manistee River, Michigan. To prepare for re-introduction of this species within State waters it is important to examine Arctic Grayling life history and present abiotic and biotic conditions (Danhoff et al. 2017). Information on early life of Arctic Grayling is scarce (Kratt & Smith 1977), but studies in Montana, Canada, and Europe on a sister species (*Thymallus thymallus*), provide some information on habitat suitability (Northcote 1993, Lamothe & Magee 2004, Stewart et al. 2007).

Arctic Grayling are a cold-water species known to spawn annually upon reaching sexual maturity, which varies by region ranging from two to six years old (Northcote 1995). Like other salmonid species, Arctic Grayling return to spawn in natal waterways (Tack 1980, Hop 1985, Northcote 1995). Adults migrate to these streams and rivers just after spring ice out (Haugen & Vøllestad 2000) at temperatures around 4°C and spawn around 5-9°C with maximum at 16 °C (Northcote 1993). Depending on factors such as lake, year, location and elevation, the timing of spawning can start as early as late April and end in mid-June (Northcote 1995).

Generally, Arctic Grayling spawn in areas of streams and rivers that are shallow (< 1 m), and have gravel or rocky substrates with moderate flow (< 150 cm/s) (Stewart et al.

¹ The material contained in this chapter is in preparation for submission to a journal.

2007). Unlike other salmonid species, male Arctic Grayling set up spawning territories rather than defend access to a female (Beauchamp 1981). Females do not construct redds prior to egg release or cover their eggs after fertilization. However, shallow pits appear as the result of pre-spawning activities (Northcote 1993) and the demersal, adhesive eggs will move into cracks and crevices between rocks (Northcote 1995) allowing eggs to lay a few centimeters underneath the gravel surface. Females in Canada and Washington State (U.S.) produce between 1,200 – 17,000 eggs, and hatching occurs within 130-140 degree days (~3 weeks) (Northcote 1995). Compared to eggs of other salmonid species, Arctic Grayling eggs are small, ranging from 2 to 3 mm in diameter prior to fertilization, 2.7 mm on average when water hardened, and swell for 3 to 4 days to reach 3.5 to 4 mm in diameter (Northcote 1993).

Arctic Grayling begin to emerge on average 3-4 days after hatch; length varies among systems but larvae are between 7-15 mm TL (Kratt & Smith 1977, Northcote 1995). Larval Arctic Grayling are very poor swimmers, especially at swim-up, for about two weeks (Kratt & Smith 1977, Deleray & Kaya 1992, Stewart et al. 2007). Due to their poor swimming ability, they are highly susceptible to displacement in flooding and drought (Armstrong 1986). Arctic Grayling fry begin eating about nine days after hatch and actively prey upon zooplankton, mayfly nymphs, Diptera pupae and cladocerans (Bishop 1967, Stewart et. al. 2007). Arctic Grayling fry will school together for about 3 weeks after swim-up in shallow, calm water with little flow and since they are surface swimmers they need 90% overhead vegetation or instream boulders for protection (Vascotte 1970).

The objective of this research is to test the feasibility of using Remote Site Incubators (RSIs) (Figure 1) for Arctic Grayling reintroduction in Michigan. In past reintroduction efforts in the state, the usual method was to stock hatchery-reared fingerlings or yearlings directly into the river (Nufher 1992). Recently, the use of RSIs has been shown as a successful alternative to establish or reestablish some salmonid species, including Arctic Grayling, at remote locations (Donaghy & Verspoor 2000, Kaeding & Boltz 2004, Al-Chokhachy et al. 2009). RSIs are self-contained incubators that permit the hatching of eggs and release of swim-up fry directly at a field site. Advantages of this method include reducing the effects of sedimentation on eggs (Kaeding & Boltz 2004) and introducing eggs and fry to natural stream water chemistry and conditions facilitating potential imprinting on natal waters (Kirkland 2012). Higher swim-up rates have also been observed in RSI-reared eggs compared to those of wild-spawned eggs (Kruse 1959, Lund 1974, Olsson & Persson 1986, Syrjanen et al. 2008).

The use of RSIs for incubation and swim-up was successful in the Yankee Fork River in the Salmon River Basin, Idaho in 1995 to produce Chinook Salmon (*Oncorhynchus tshawytscha*) using fungicide-treated eggs resulting in an average 85% survival of eyed-eggs to hatch (Denny et al. 2012). In the state of Washington, untreated Chinook salmon eggs in RSI's exhibited an average survival rate of 95% from egg to hatch (Wampler & Manuel 1992). This method was also used for Westslope Cutthroat Trout (*Oncorhynchus clarki lewisi*) at Libby Dam in Montana (Hoffman et al. 2002) resulting in a yearly average survival between 53% and 75% in 1997-2000 from egg to hatch. Investigations using Arctic Grayling in Upper Red Rock Lake, Montana have resulted in an average

44% survival from egg to hatch (Kaeding & Boltz 2004) and 90% survival in the Sun River, Montana (Magee et al. 2004).

The purpose of this study was to investigate methodology of using RSIs and their feasibility for use under laboratory conditions mimicking native Michigan rivers. We tested the hypothesis that egg density does not impact survival to hatch and swim-up of three salmonid species used in RSIs under laboratory conditions and methodology for hatch and swim-up success would not be achieved for all three salmonid species.

Research objectives were:

1. To assess optimal egg density to use in a RSIs which produces the highest survival rate from egg to hatch and then swim-up for Brook Trout, Rainbow Trout and Arctic Grayling.
2. To determine if RSIs could be effective and achieve comparable results to RSI units operated in field conditions for eggs and swim-up fry of three salmonid species.

2. Methods

Three species, Rainbow Trout (*Oncorhynchus mykiss*), Brook Trout (*Salvelinus fontinalis*) and Arctic Grayling (*Thymallus arcticus*), were used in egg survival and swim-up studies (Table 1 and Table 2). Experiments were conducted at MTU using two large Living Stream tanks (Frigid Units Inc., Toledo, Ohio). These tanks held three RSIs each and lake water was pumped continuously from the Portage Canal which transects the peninsula. A filter system (Ocean Clear, Houston, TX, USA) was used to decrease sediment build up. Each RSI was constructed using a 19l (5 gallon) bucket with a lid,

PVC pipe water delivery system, rock substrate (for Brook and Rainbow Trout studies) and an egg tray following Kaeding and Boltz, 2004 (Figure 1). Flow was increased just below the point at which eggs would roll. Water percolated up through a diffuser through the bucket and exited through the out flow near the top, and a meshed basket was placed below the outlet to collect all swim-up fry. A plastic 0.64 cm mesh tray (Industrial Netting, Brooklyn, PA) held gravel substrate and fertilized eggs. The gravel in the bucket simulated natural spawning habitat and provided habitat for fry to continue to develop before swim-up and moving through the “out flow” (Kaeding & Boltz 2004, Rupert & Ruhl 2008).

The outlet of each Living Stream had a mesh screen nursery egg bag (volume 2500 cm³) to collect swim-up fry. An Onset (HOBO Pendant, Onset Computer Corporation, Bourne MA) temperature (°C) and light (LUX) logger was located among the gravel of one RSI in each Frigid tank. Water temperature was also measured manually each day and dead eggs/fry removed, counted, and time to hatch, swim-up and developmental stage (eyed, hatch, and swim-up) were recorded. Hatch fry were not feed as they were euthanized at swim-up. Weekly pH and water velocity (ml/min) measurements were recorded as was light intensity using a PAR meter (Quentun Flux, Model MQ-200). Illumination mimicked the natural cycle of the time of year that each species would normally experience, and during monitoring activities, eggs were shielded from direct light and disturbance was minimized.

Low, medium, or high density of eggs was determined by the size of the eggs and number of eggs received for each species of fish (Table 3). Arctic Grayling densities were based

on Magee et al. (2004) who used 1,400 fertilized eggs per RSI in a single layer. Overall we had fewer eggs to work with so we reduced the area for each batch of eggs. Eggs in our study were acclimated to lake water temperatures (15 minutes) prior to placing them in egg trays. All living fish that swam up were collected, euthanized with MS222 (Tricaine-S, Western Chemical, Inc., Ferndale WA.) and placed in 10% formalin, counted and measured to total length (TL (mm)). TL (mm) and average depth of yolk sac (mm) were recorded for Brook Trout and Arctic Grayling.

2.1 Rainbow Trout

Rainbow Trout eggs were received on 22 April 2015 (Day one), from the Little River Band of Ottawa Indians Natural Resources Department in two, five-gallon, uninsulated buckets in oxygen injected water, and transported over ice. They were treated with a 10.0% Povidone-Iodine treatment (Ovadine, Western Chemical Inc., Ferndale WA) to reduce bacteria on arrival to MTU for ten minutes and handled with a brine shrimp net. Since we had a large number of eggs to work with a single density was used in each RSI, the area of each RSI screen being 707 cm². We estimated the number of eggs used in each RSI by filling a 25 ml graduated cylinder with eggs and determining the average number (average = 205 eggs/25 ml, SD ± 28.34). Hoping to reach a low density (n=800), medium (n=1200) and high (n=1600), eggs were measured into freezer bags with original transport water (13 °C) and allowed to acclimate to the temperature in the RSI (5 °C) before being added to the RSI (Table 4).

2.2 Brook Trout

For this trial, we used plastic mesh to divide the egg mesh-holding screen into three equal sections (236 cm² each). On 5 November 2015 (Day one) approximately 5400 Brook

Trout eggs were collected from the Cherry Creek Hatchery (Marquette, MI). They were transported in freezer bags and stored in a cooler filled with hatchery water (8°C). Eggs were treated on site with iodine until eggs were water hardened to destroy Bacterial Kidney Disease (BKD) and cold water bacteria. On arrival to MTU, eggs were sorted into six RSI's at low (n=266) or medium (n=400) density.

2.3 Arctic Grayling

Arctic Grayling eggs were received in two shipments of eggs from Montana. The first shipment was of green, day-old fertilized eggs, and the second shipment was of 5 day old eyed eggs, a more stable developmental period for fish eggs. On 15 May 2016 (Day one) 2500 green Arctic Grayling eggs from the Green Hollow Grayling Brood Pond in Bozeman, Montana were shipped to MTU overnight. Eggs arrived in a cooler, and were packaged “dry”. Upon arrival to MTU Grayling eggs were put into 11 °C water and sorted into six RSIs (3 per Frigid Tank) at high density (n=200) only and placed in socks of plastic mesh (0.24 cm) at 1/6th the area of the mesh flooring an area of 118 cm². On 20 May 2016 a second shipment of about 2500 “eyed” Arctic Grayling eggs arrived at MTU overnight. Eggs arrived in a thermal egg shipper with crushed ice and a starting temperature of 8 °C. Since we had fewer eggs to use for Arctic Grayling they were sorted into similar 118 cm² area socks using high density (n=200) and medium (n=160) at water temperatures of 14°C.

2.3 Data Analysis

The percent survival to hatch and swim-up were calculated as the difference between the number of fertilized eggs placed into the RSI and the total counts of dead eggs and larvae that were subsequently removed. A linear mixed effect model was used to compare the

two tanks to determine if there was any difference among RSIs, flows, treatments and tanks (R Studio, Boston, MA). Since no difference (p value =1) was found, all replicates of densities for both tanks were grouped together for the Brook Trout (duration 184 days) and Arctic Grayling (duration 18 days) experiments for further analysis. The linear mixed model also compared Arctic Grayling high density eyed-eggs, medium density eyed-eggs, and high density green eggs with an alpha of 0.05

3. Results

A summary of results for each species of fish used in the study shows the variation in incubation time (Table 5) and duration to hatch and swim-up for the three species used in this study (Table 6). For all tank experiments the HOBO light recorder indicated 0 LUX for the duration of the experiments, and flow for the RSI units averaged $45.9 \text{ cm}^3/\text{sec}$ ($41.78\text{-} 50.0 \text{ cm}^3/\text{sec}$).

3.1 Rainbow Trout

On 23 May 2015 (Day 31 of incubation), eggs began to hatch, and swim-up began 12 days later on 4 June 2015 (Day 43). Average percent egg survival for the three RSIs in each tank was 84% low density, 87% medium density and 87% high density. The average percent survival to swim-up was 68% low density, 70% medium density and 78% high density (Figure 2.A and Table 5).

3.2 Brook Trout

The Brook Trout incubation time was the longest of any of the three species studied as eggs did not begin to hatch until 22 February 2016 (Day 108) and swim-up began on 18 April 2016 (Day164). Water temperatures during this period were 4.5°C at hatch and 5.6°C at swim-up. All six replicates from the two Frigid Tanks were grouped together for

analysis. Brook Trout eggs at low density showed percent survival to hatch at 67% (SD 6.0) and at medium density was 80% (SD 6.0), we did not have a high density group for this species. Survival to swim-up at low density was 45% (SD 29.0) and at medium density was 39% (SD 13.0) (Table 5). The average depth of the yolk sac (mm/total length) for each date of swim-up was calculated and compared to the average daily temperature and shows that as the incubation time increased size of the yolk sac decreased at a rate of -0.03 mm/day. As the total length of the swim-up fry increased over time the average depth of the yolk sac decreased as well (Figures 2.B and 3.B).

3.3 Arctic Grayling

Arctic Grayling eggs hatched over a shorter time period than was seen for the other two salmonid species studied. While green eggs were placed in RSIs on 15 May, eyed-eggs were placed in RSIs on 20 May 2016. On 23 May 2016 (Day 9), the green eggs began to hatch, and swim-up began on 28 May 2016 (Day 14) just 8 and 13 days after arrival, respectively. Since we had fewer eggs and they were smaller in size we placed them in smaller units (mesh socks) at medium and high density only. Percent survival to hatch for high density green eggs was 15% (SD 11.0) while for eyed-eggs survival at medium density was 96% (SD 2.0), and high density 96% (SD 3.0). Survival to swim-up for the green eggs was poor with only 8% (SD 8.0) surviving. The eggs shipped at the eyed stage performed much better with survival to swim-up being 54% (SD 23.0) at medium density, and survival at 77% (SD 13.0) at high density (Figure 2.C and Table 6).

The liner mixed model indicated that a treatment effect is present (p value = 0.0000). By fitting linear models to the high density intercept we showed that there is a treatment

effect between high density eyed-eggs, medium density eyed-eggs, versus high density green eggs. This is supported by Student's t-test of high density eyed-eggs versus high density green eggs (p value= 0.0001) and medium density eyed-eggs versus high density green eggs (p value= 0.0032) Figure 3.A. shows the average depth of the yolk sac (mm) divided by the total length of the larvae (mm) for each day of swim-up and compared to the average daily water temperature. The size of the yolk sac decreased as the duration of experiment and temperature increased. As the total length of the swim-up larvae increased over time the average depth of the yolk sac decreased (Figure 4).

4. Discussion

It was encouraging to see that when using RSIs the 65% average percent swim-up of Arctic Grayling fry from our study is similar to the average 67% emergence seen in RSI field studies from Montana (Kaeding and Boltz 2004). Overall, emergence rates from RSIs in our study were greater than those seen for wild spawning Arctic Grayling of only 2-4% Wyoming (Kruse 1959) and 1% Montana (Lund 1974). Eyed-eggs are frequently used for stocking in RSIs because eggs are less susceptible to clumping and fungus (Hershall 1907) and they show a reduced development time (Magee et al. 2004). With increased survival over wild spawned eggs and facilitating potential imprinting on natal waters (Kirkland 2012), RSIs should be an effective technique in the establishment of Arctic Grayling populations in select Michigan tributaries.

The Rainbow and Brook Trout trials allowed for experimentation using live eggs of the Salmonidae family to better understand how to operate the RSIs. Properly functioning RSIs can have hatch success rates that can exceed 95% (Kirkland 2012). For Rainbow

Trout, our hatch was 86% which is higher than RSIs tested in the Salmon River Basin that achieved 81.9% hatch (Denny et. al. 2012). In the wild, Rainbow Trout survival can be from 46% to 92% from egg to emergence (Dahlberg 1979). Hatch typically happens in an average of 42 days and swim-up happens by 56 days at temperature of 12 °C (Hinshaw and Thompson 2000).

Since we circulated lake water in the study tanks, the Brook Trout eggs had a longer incubation time, it was encouraging to see that some Brook Trout eggs survived the cold temperatures experienced over winter which would not have occurred in eggs in natural groundwater fed stream. Low temperatures near 4 °C were recorded in late April early May for the water used in our RSIs. Heft (2006) described the average optimal water temperature of 9 °C for development and hatching success of Brook Trout. Hatching times vary at water temperatures of 4.5 to 11.5 °C with 4.5 °C shown to be the minimum temperature to reach the eyed-egg stage. However Embury (1934) found development still occurring at temperatures of 1.7 °C but with higher mortality and less robust fry. Our average Brook Trout hatch of 74% was higher than what was reported in the literature of 56% hatch but our study experienced a lower fry emergence of 42% which was lower than the 52 % swim-up in a laboratory study by Bascinar and Okumus (2004). An investigation of several studies found in the wild most hatching occurs by 73 days at 6.2°C for Brook Trout and swim-up by 135 days (Hale and Hilden 1970).

Arctic Grayling eggs are much smaller in size than Rainbow Trout and Brook Trout with smaller yolks. As a result, they have a much shorter time to hatch and swim-up. In our study, we observed Rainbow Trout and Brook Trout larvae remained among the substrate

or just above until swim-up. This was also observed by Hale and Hilden (1970) for Brook Trout, yet was not true for Arctic Grayling who were observed to swim higher in the RSI towards the surface soon after hatch. This is due to Arctic Grayling swimming up in a few days after hatching where Rainbow Trout and Brook Trout stay among the substrate for longer durations after hatching. Arctic Grayling are also visual predators and feed shortly after hatch (Bishop 1967).

Arctic Grayling larvae are smaller (10 to 15 mm TL) compared to the Brook Trout (10 to 25 mm TL) or Rainbow Trout (20 to 28 mm TL). Kaya (1991) noted that swim-up Arctic Grayling were 9-11 mm TL and Walting and Brown (1955) saw larvae 7.4 – 11.3 mm TL which is similar to those seen in our experiment. Arctic Grayling are also weaker swimmers than other young trout (Kaya 1991) and would need to be protected from flooding and droughts.

Overall Arctic Grayling require overhead or over hanging vegetation and instream rocks for cover and they are inadequate swimmers. Due to these specific needs picking habitat to place eggs is very important. RSI's would allow managers to place eggs in optimal habitat to increase survival post swim-up.

5. Conclusion

New efforts at restoration of the Arctic Grayling in Michigan would have a positive impact on the biodiversity of the fisheries in the State as well as restoring cultural heritage for the Native American Tribes. As shown in the past with the restoration of the Lake Sturgeon, indigenous paradigms are important in management of native species and

using unified restoration approaches can enhance ecological and societal values (Holtgren 2016).

This study revealed that the variance around egg density should be studied farther along with using this methodology in river systems slated for re-introduction efforts.

Investigating the importance of fluctuating water temperatures on survival to hatch and swim-up in Arctic Grayling will also help determine best methods of using RSIs. The biggest challenge in our study was tracking numbers of eggs that hatched (and fry that swam-up) vs those that died. Dead eggs and small fry quickly decomposed in sediment on the RSI bottom which was unavailable for inspection without dismantling the entire unit. However our laboratory study showed that the RSI methodology could be successful in the reintroduction of Arctic Grayling and had survival to swim-up at equal or greater numbers than current studies in Montana streams. The State of Michigan working with Tribal partners and others are considering re-introduction attempts in the near future. We have learned from this study and those conducted in Montana that using RSIs is critical to success by allowing placement in remote stream sites for best success.

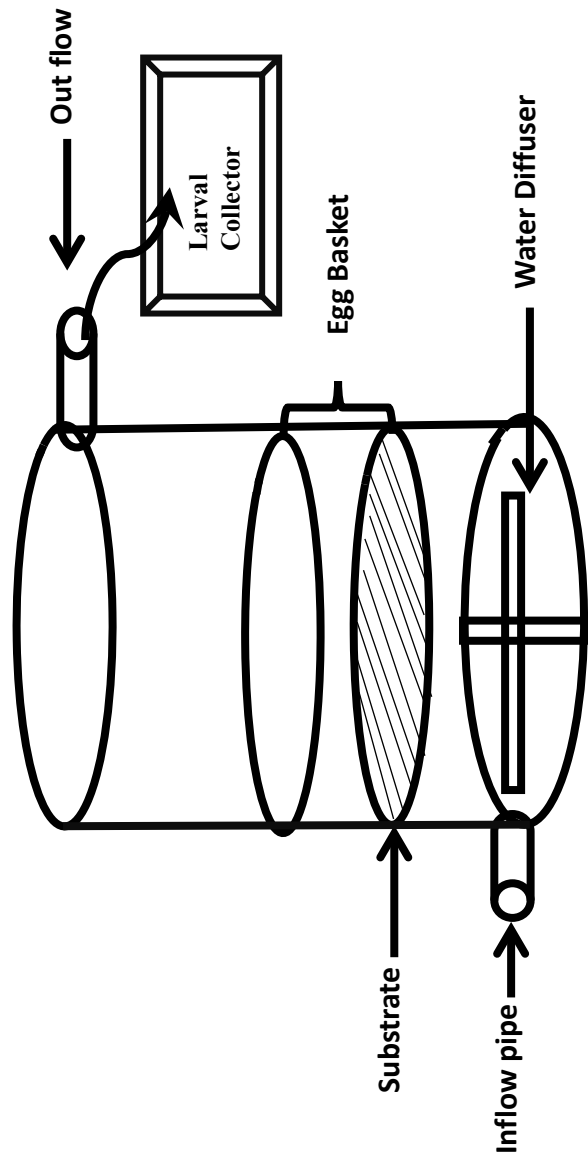

Figure 1. Illustration of Remote Site Incubator used in successful field introductions of different salmonid species (adapted from Rupert & Ruhl 2008).

Table 1. Comparison of egg size, incubation time and temperature for three salmonid species. Data adapted from 1, Auer 1986; 2, Hinshaw & Thompson 2000; 3, Heft 2006; 4, Tyler et al. 1996, 5, Stewart et al. 2007.

Fish Species	Egg Diameter (mm)	Incubation Time Days	Temperature (°C)
Rainbow Trout (<i>Oncorhynchus mykiss</i>) ^{1,2,4}	4-5	29- 49 days	10-15
Brook Trout (<i>Salvelinus fontinalis</i>) ³	3.5-5	95-100 days	4.5-11.5
Arctic Grayling (<i>Thymallus arcticus</i>) ⁵	2-3	13-18 days	4-16

Table 2: Abiotic characteristic of three species tested in 2015 and 2016 during RSI testing. Data from 1, Lane et al. 1996; 2, Ross 2001; 3, Heft 2006; 4, Danhoff et al. 2017.

Fish Species	Average Water Velocity cm/sec	Spawning Substrate cm	Fry Substrate	Dissolved Oxygen (mg/L)	pH
Rainbow Trout ^{1,2} (<i>Oncorhynchus mykiss</i>)	45.7 – 60.9	Fine gravel 0.6- 7.6	----	1.6 -2.6	7.0-8.0
Brook Trout ³ (<i>Salvelinus fontinalis</i>)	Base flow > 55%	3- 6 gravel	3-6 gravel < 5% fines	----	6.5- 8.0
Arctic Grayling ⁴ (<i>Thymallus arcticus</i>)	34 – 146	Gravel- Pebble	Fines- Pebble	1.7- 11.2	7.0 -8.2

Table 3: Egg number for the three salmonid species during RSI testing 2015-2016.

Species	Egg Density		
	Low	Medium	High
Rainbow Trout	800	1200	1600
Brook Trout	266	400	---
Arctic Grayling	---	160	200

Table 4: RSI testing with Rainbow Trout eggs April 2015 to June 2015. Egg densities were 1600, 1200 and 800 per one RSI unit.

RSI	*Number of eggs desired	Substrate	Total mls of eggs	Estimated Total # eggs
1	1600	Pebble/Cobble	200	1621
2	1600	Pebble/Cobble	200	1627
3	1200	Pebble/Cobble	150	1218
4	800	Pebble/Cobble	100	812

Table 5. Results of duration to egg hatch for each fish species used in RSI testing 2015-2016

Fish Species	Egg Diameter (mm)	To Hatch Time Days	Temperature (°C)
Rainbow Trout	4-5	31	15
Brook Trout	3.5-5	108	4
Arctic Grayling	2-3	11	14

Table 6. Results of duration to hatch and swim-up and % at each density for the three salmonid species used for RSI testing 2015-2016.

Species	# Day	Hatch %			# Day	Swim-up %		
		Low	Medium	High		Low	Medium	High
Rainbow Trout	31	84	87	87	43	68	70	78
Brook Trout	108	67 (5.0)	80 (6.0)	87	164	45 (29.0)	39 (13.0)	77
Arctic Grayling	11		96 (2.0)	96 (3.0)	15		54 (23.0)	77 (13.0)

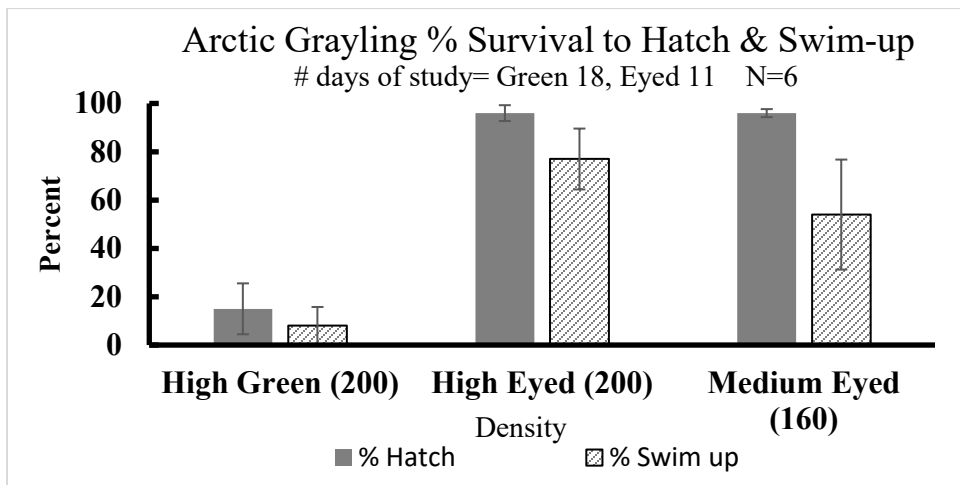
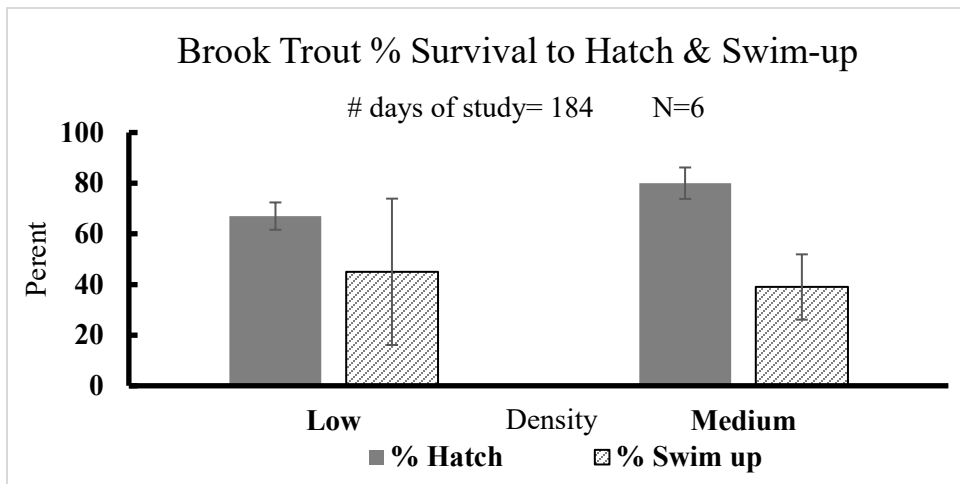
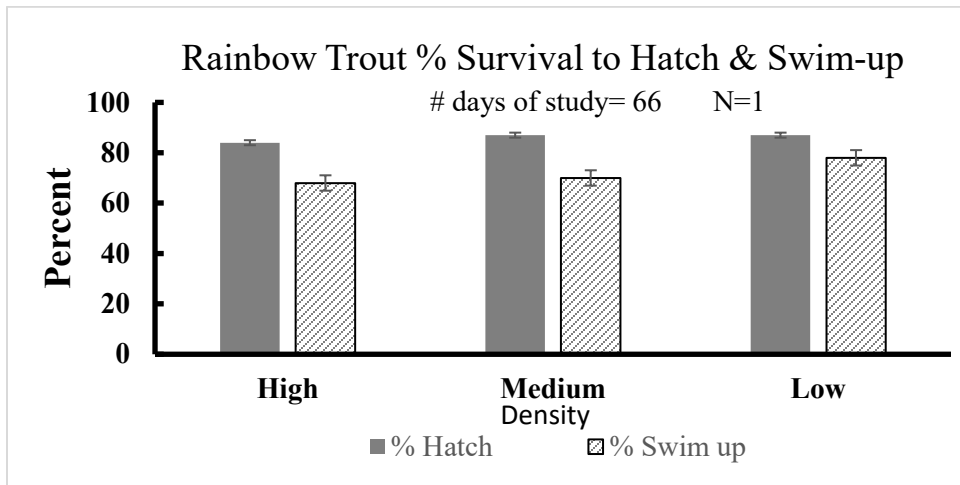

Figure 2. Graphs A, B, and C show the Rainbow Trout, Brook Trout and Arctic Grayling eggs estimated percent survival to hatch and survival to swim-up, 2015-2016.

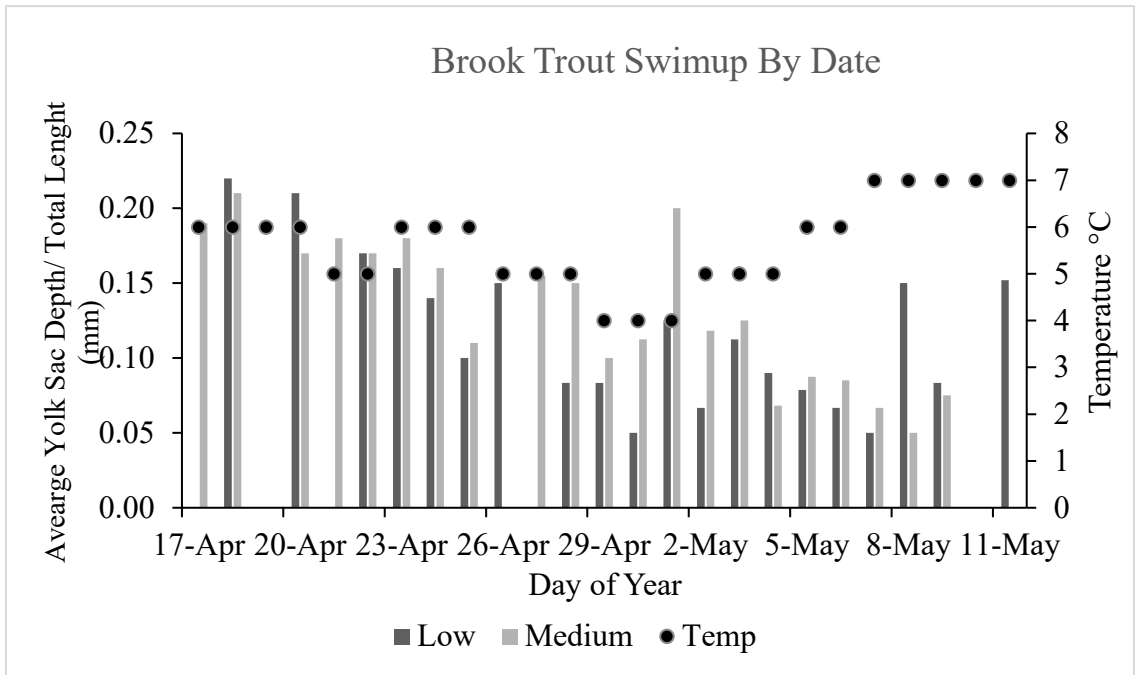
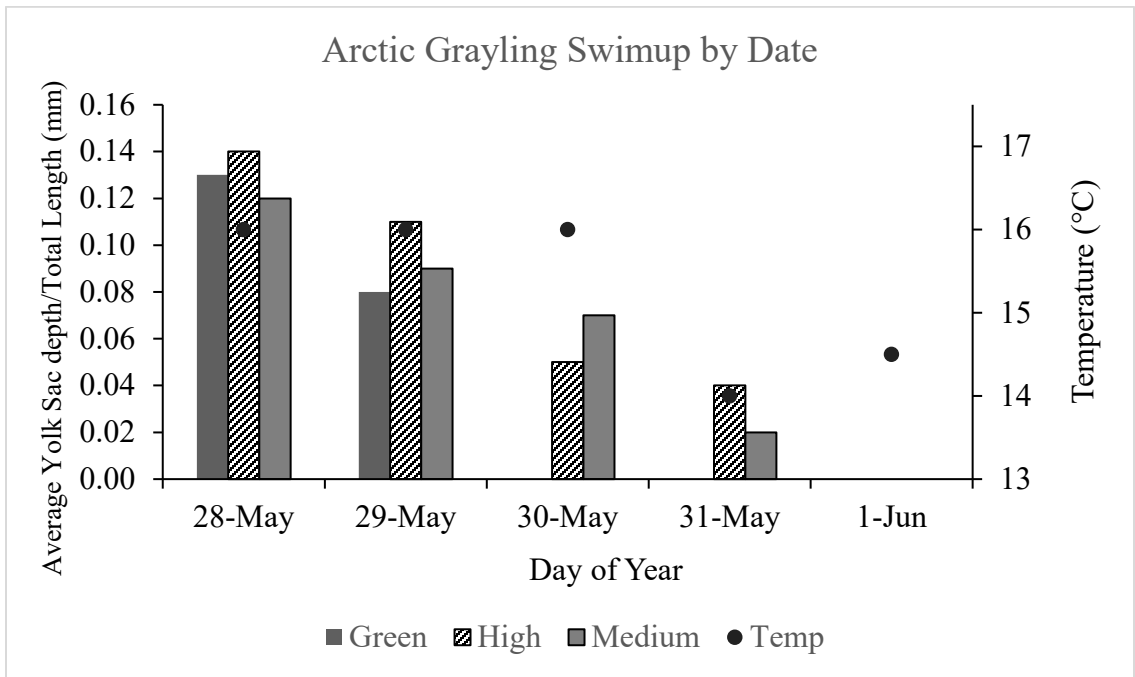

Figure 3. Graph A and B display the ratio of depth of the yolk sac to total length of the larvae by date of hatch or swim-up and average daily water temperature.

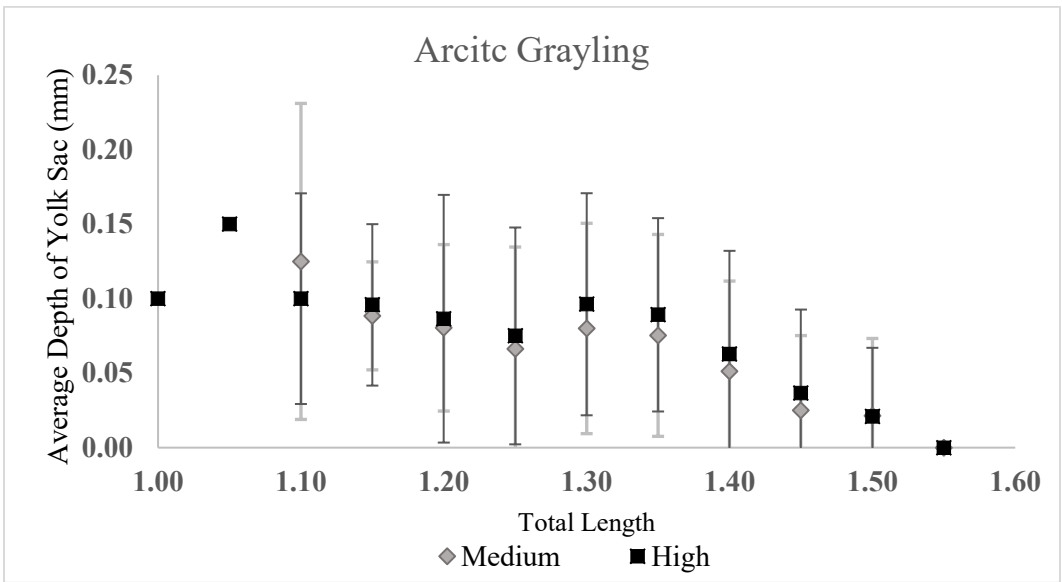

Figure 4. Average depth of the yolk sac compared to the total length of the larval Arctic Grayling.

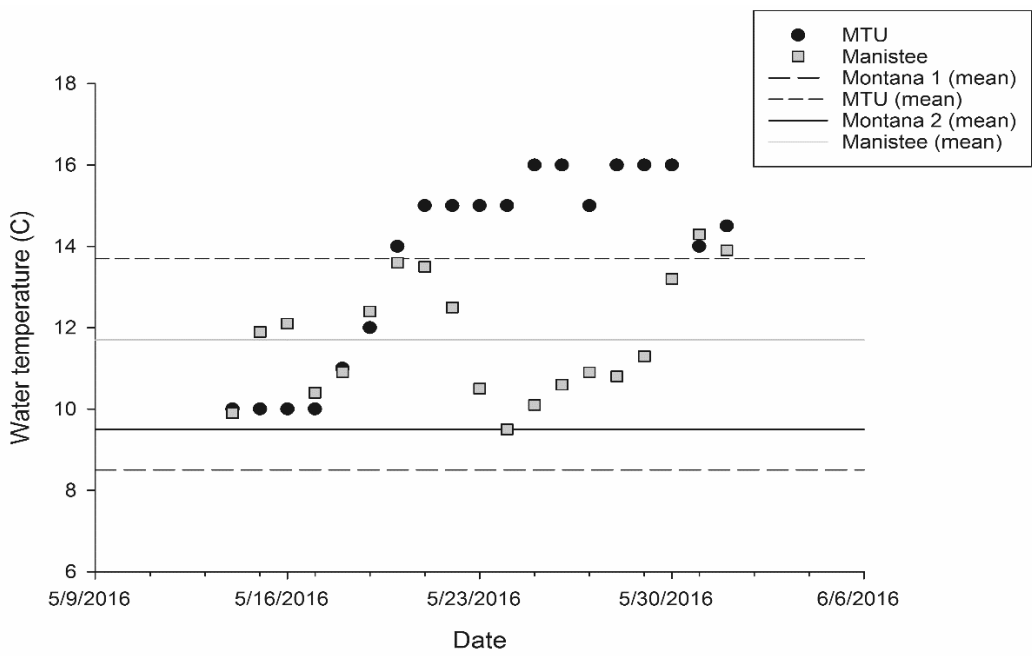

Figure 5. Average water temperatures in Montana RSI field studies during Grayling hatch compared to those in MTU RSI lab compared to the Slagle Creek, Big Manistee River tributary, spring water temperatures expected.

References

- Armstrong, R. H. (1986). *A review of Arctic grayling studies in Alaska, 1952-1982*. University of Alaska. Institute of Arctic Biology, 17.
- Auer, N. A., editor. (ed.). 1982. Identification of larval fishes of the Great Lakes basin with emphasis on the Lake Michigan drainage Special Pub. 82-3, Great Lakes Fishery Commission, Ann Arbor, MI.
- Al-Chokhachy, R., Peacock, M., Heki, L. G., & Thiede, G. (2009). Evaluating the reintroduction potential of Lahontan cutthroat trout in Fallen Leaf Lake, California. *North American Journal of Fisheries Management*, 29(5), 1296-1313.
- Bascinar, N. and Okumus, İ. (2004). The early development of brook trout *Salvelinus fontinalis* (Mitchill): Survival and growth rates of alevins. *Turkish Journal of Veterinary and Animal Sciences*, 28(2), 297-301.
- Beauchamp, D. (1981). The life history and spawning behavior of the Arctic grayling. In Brannon, E.L. and Salo, E.O., es. *Salmon and Trout Migratory Behavior Symposium*. Seattle: University of Washington, p.274.
- Bishop, F. G. (1967). The biology of Arctic grayling, *Thymallus arcticus*. *Great Slave Lake. Master's Thesis, University of Alberta, Edmonton, AB xi+ 165*.
- Dahlberg, M. D. (1979). A review of survival rates of fish eggs and larvae in relation to impact assessments. *Marine Fisheries Review*, 41(3), 1-12.
- Danhoff, B.M., Huckins, C. J., Auer, N.A., Goble, C.W. Ogren S.A., Holtgren, J.M. (2017). Assessment of abiotic conditions in the big Manistee River, MI, system as potential Arctic Grayling habitat. *Transactions of the American Fisheries Society* (In press).
- Deleray, M. A., & Kaya, C. M. (1992). Lakeward and downstream movements of age-0 arctic grayling (*Thymallus arcticus*) originating between a lake and a waterfall. *The Great Basin Naturalist*, 344-351.
- Donaghy, M. J., & Verspoor, E. (2000). A new design of instream incubator for planting out and monitoring Atlantic salmon eggs. *North American Journal of Fisheries Management*, 20(2), 521-527.
- Denny, L. P., Evans, D. J., & Tribes, S. B. (2012). Steelhead Streamside Incubation Program, 17.
- Embody, G. C. (1934). Relation of temperature to the incubation periods of eggs of four species of trout. *Transactions of the American Fisheries Society*, 64(1), 281-292.

- Hale, J. G., & Hilden, D. A. (1970). The influence of flow on the spawning of brook trout in the laboratory. *Transactions of the American Fisheries Society*, 99(3), 595-597.
- Haugen, T. O., & Vøllestad, L. A. (2000). Population differences in early life-history traits in grayling. *Journal of Evolutionary Biology*, 13(6), 897-905.
- Heft, A. A. ed. (2006). Maryland brook trout fisheries management plan. *Maryland Department of Natural Resources Fisheries Service Inland Fisheries Management Division DCNR Bureau of Forestry*, 130.
- Henshall, J. A. 1907. *Culture of the Montana grayling*, Report of the U.S. Commissioner of Fisheries, Bureau of Fisheries Document No. 628 Washington, D.C.
- Hinshaw, J. M., Thompson S. L. (2000). Trout production: handling eggs and fry. *SRAC publication (USA)*. 223, 1-4.
- Hoffman, G., Marotz, B., DeShazer, J., Garrow, L., Ostrowski, T., & Dunnigan, J. (2002). Mitigation for the Construction and Operation of Libby Dam. *Annual Report. Montana Fish, Wildlife and Parks. BPA Project*, (199500400), 159.
- Hop, H. (1985). *Stock Identification and Homing of Arctic Grayling, Thymallus Arcticus (Pallus), in Interior Alaska*. Alaska Cooperative Fishery Research Unit, University of Alaska, 220.
- Kaeding, L. R., & Boltz, G. D. (2004). Use of remote-site incubators to produce arctic grayling fry of wild parentage. *North American journal of fisheries management*, 24(3), 1031-1037.
- Kaya, C. M. (1991). Rheotactic Differentiation between Fluvial and Lacustrine Populations of Arctic Grayling (*Thymallus arcticus*), and Implications for the Only Remaining Indigenous Population of Fluvial" Montana Grayling". *Canadian Journal of Fisheries and Aquatic Sciences*, 48(1), 53-59.
- Kirkland, D. (2012). A review of factors influencing artificial salmonid incubation success and a spate river-specific incubator design. *Fisheries Management and Ecology*, 19(1), 1-9.
- Kratt, L. F., & Smith, R. J. F. (1977). A post-hatching sub-gravel stage in the life history of the Arctic grayling, *Thymallus arcticus*. *Transactions of the American Fisheries Society*, 106(3), 241-243.
- Kruse, T. E. (1959). Grayling of Grebe Lake, Yellowstone National Park, Wyoming, 46.

- Lamothe, P., and Magee, J. (2004) *Reintroducing fluvial arctic grayling (Thymallus arcticus) to the upper ruby river MT: a progress report; February 2004*. Montana Fish, Wildlife and Parks. Dillon, Montana (406), 683-2675
- Lane, J. A., Portt, C. B., & Minns, C. K. (1996). *Spawning habitat characteristics of Great Lakes fishes*. Fisheries and Oceans Canada, 2368.
- Lund, J. A. (1974). *The reproduction of salmonids in the inlets of Elk Lake, Montana* Master's thesis, Montana State University, 70.
- Magee, J.P. Rens, E., Lamthe, P. (2004). *Fluvial arctic grayling monitoring report 2004*. Montana Fish, Wildlife and Parks. Dillon, Montana, 46.
- Northcote, T. G. (1993). *A review of management and enhancement options for the Arctic grayling (Thymallus arcticus) with special reference to the Williston Reservoir watershed in British Columbia*. Province of British Columbia, Ministry of Environment, Lands and Parks, Fisheries Branch, 69.
- Northcote, T. G. (1995). Comparative biology and management of Arctic and European grayling (Salmonidae, Thymallus). *Reviews in fish biology and fisheries*, 5(2), 141-194.
- Nuhfer, A. J. (1992). Evaluation of the Reintroduction of the Arctic Grayling, into Michigan Lakes and Streams. *Fisheries Research*, 1985.
- Olsson, T. I., & Persson, B. G. (1986). Effects of gravel size and peat material concentrations on embryo survival and alevin emergence of brown trout, *Salmo trutta* L. *Hydrobiologia*, 135(1-2), 9-14.
- Stewart, D.B., Mochnacz, N.J., Reist, J.D., Carmicheal, T.J., & Sawatzky C.D. (2007). Fish life history and habitat use in the Northwest Territories: Arctic grayling (*Thymalus arcticus*). *Canadian Manuscript Report of Fisheries and Aquaculture Science*, 2797, 55
- Syrjänen, J., Kiljunen, M., Karjalainen, J., Eloranta, A., & Muotka, T. (2008). Survival and growth of brown trout *Salmo trutta* L. embryos and the timing of hatching and emergence in two boreal lake outlet streams. *Journal of Fish Biology*, 72(4), 985-1000.
- Rupert, D. L., & Ruhl, M. E. (2008). Yellowstone National Park Westslope Cutthroat Trout Restoration Program: 2008 Field Season Strategy.
- Ross, S. T. (2001). *The inland fishes of Mississippi*. Univ. Press of Mississippi, 17.

- Tack, S. L. (1980). Migrations and distribution of arctic grayling in interior and arctic Alaska. *Alaska Dept Fish Game, Ann. Rep. Progress., 1979-1980, Project F-9-12, 21(R-I)*. 32.
- Tyler, C. R., Pottinger, T. G., Santos, E., Sumpter, J. P., Price, S. A., Brooks, S., & Nagler, J. J. (1996). Mechanisms controlling egg size and number in the rainbow trout, *Oncorhynchus mykiss*. *Biology of Reproduction*, 54(1), 8-15.
- Vascotto, G.L. (1970) Summer ecology and behavior of the grayling of McManus Creek, Alaska. MSc thesis, Univ. Alaska, College, AL. 132 pp.
- Wampler, P.L, Manuel. J.L.(1992). A test of remote site incubators using green, untreated fall chinook eggs. Unpublished Report. U.S. Fish and Wildlife Service, Olympia, WA, 10.
- Watling, H., & Brown, C. J. D. (1955). The embryological development of the American grayling (*Thymallus signifer tricolor*) from fertilization to hatching. *Transactions of the American Microscopical Society*, 74(1), 85-93.