



**Michigan
Technological
University**

Michigan Technological University
Digital Commons @ Michigan Tech

Dissertations, Master's Theses and Master's Reports

2019

PERFORMANCE IMPROVEMENT OF A SINGLE CYLINDER, AIR-COOLED, SPARK-IGNITED ENGINE UTILIZING 1-D CYCLE SIMULATION

Chun Wang

Michigan Technological University, chunw@mtu.edu

Copyright 2019 Chun Wang

Recommended Citation

Wang, Chun, "PERFORMANCE IMPROVEMENT OF A SINGLE CYLINDER, AIR-COOLED, SPARK-IGNITED ENGINE UTILIZING 1-D CYCLE SIMULATION", Open Access Master's Report, Michigan Technological University, 2019.

<https://doi.org/10.37099/mtu.dc.etr/888>

Follow this and additional works at: <https://digitalcommons.mtu.edu/etr>

PERFORMANCE IMPROVEMENT OF A SINGLE CYLINDER, AIR-COOLED,
SPARK-IGNITED ENGINE UTILIZING 1-D CYCLE SIMULATION

By

Chun Wang

A REPORT

Submitted in partial fulfillment of the requirements for the degree of

MASTER OF SCIENCE

In Mechanical Engineering

MICHIGAN TECHNOLOGICAL UNIVERSITY

2019

© 2019 Chun Wang

This report has been approved in partial fulfillment of the requirements for the Degree of MASTER OF SCIENCE in Mechanical Engineering.

Department of Mechanical Engineering – Engineering Mechanics

Report Advisor: *Dr. Scott A. Miers*

Committee Member: *Dr. Jason R. Blough*

Committee Member: *Dr. David D. Wanless*

Department Chair: *Dr. William W. Predebon*

Table of Contents

Abstract.....	v
1 Introduction.....	1
1.1 Main Project Goal	1
1.2 Objectives and Tasks.....	2
2 Theoretical Power Improvement.....	3
3 Base Engine Modeling.....	5
3.1 Background Information	5
3.1.1 Engine Specifications and Output.....	5
3.1.2 Intake System Design	7
3.1.3 Cam Profile and Valve Discharge Coefficient.....	9
3.1.4 Volumetric Efficiency Calculation	10
3.1.5 Turbulent Combustion Model.....	11
3.1.6 Heat Transfer Multiplier	12
3.2 GT-Power Model of Base Engine	12
3.2.1 Exhaust Back Pressure.....	13
3.2.2 Model Assumptions	14
3.2.3 Base Engine Model Performance.....	14
3.3 Base Engine Model Tuning and Validation	15
3.3.1 Effect of Flame Speed Multiplier (FSM).....	15
3.3.2 Effect of Heat Transfer Multiplier (HTM).....	16
3.3.3 Effect of AFR.....	17
3.4 Final Model for Base Engine.....	19

4	Power Improvement Engine Modeling	21
4.1	Power Improvement Model.....	21
4.2	Improvement Tests	22
4.2.1	Effect of Spark Advance	23
4.2.2	Effect of Compression Ratio.....	24
4.2.3	Effect of Carburetor Diameter	25
4.2.4	Effect of Exhaust Back Pressure.....	26
4.2.5	Effect of Cam Timing	27
4.2.6	Effect of Cam Duration.....	29
4.2.7	Effect of Valve Lift.....	30
4.3	Final Model Performance	31
5	Conclusions and Future Work	33
6	Reference List	35

Abstract

New engine development process is time consuming and requires high cost of expenses. It is preferred to use simulation and reach goals such as meeting power targets before the engine is made. This reduces cost and shortens the development time. The major challenge of engine modeling is ensuring the model is accurately predicting the actual engine behavior. Only when the simulation results are close to the actual engine output, can the model be used for development.

The goal of this project was to increase the power output of a single-cylinder engine for a recreational vehicle application, using only a 1-D cycle simulation tool to provide insight of the required changes. It was necessary to make several assumptions during the model development because data for the engine was limited. The assumed data and specifications were obtained from technical paper references, textbooks, and from trial and error iteration until the best results were obtained. The price of development was also taken into consideration so changes applied to the engine were limited as not all modifications were practical, such as intake air boosting.

During the simulation process, it was found that late combustion was restricting the power as the engine speed increased. This was due to the fixed spark timing and was addressed by advancing it. Once this problem was solved, volumetric efficiency was found to be the major reason limiting the power output. Different trials were tested considering the development price and it was found that changing the camshaft to different settings was helpful with improving the air flow rate. The increase of compression ratio was also helpful and could be realized with minor changes to the engine setup. It was found that the carburetor minimum diameter was actually not a cause of air flow restriction.

1 Introduction

Internal combustion engines are widely used for transportation, power tools and power generation. Depending on the application, engines of all sizes are made and can be found in the market. In some occasions, the size of an engine might be limited. The more power that the engine could generate, the higher flexibility it could get. This study focuses on improving the power of a multi-purpose engine to further extend its use.

1.1 Main Project Goal

The Yamaha MZ360 multi-purpose engine was selected as a baseline engine to look for power improvement and extending its use. The engine operates in the range of 2000 – 4000 rpm and has a maximum power of 7.6 kW at 3600 rpm [2]. If the speed range was extended and the power increased, the engine would become useful for additional applications. A 1-D engine cycle simulation model was built to predict the possible performance with multiple changes. The goal was to operate the engine up to 6000 rpm and reach a power target of twice the baseline, i.e. ~15 kW.

The required minimum lifetime of a utility engine depends on the rated power, total displacement, and the application. The Code of Federal Regulations (CFR) lists the nominal useful life period for a commercial non-handheld engine, with displacement above 100 cc and maximum power below 19 kW of 1000 hours [1]. The manufacturer can choose to have a longer useful life in 100-hour increments but cannot exceed 5000 hours. The approximate doubling of the power output will more than likely reduce the useful life of the engine, from its original design. However, even if the useful life is reduced by 50%, it is believed that the engine useful life would still be deemed acceptable from a recreational-user standpoint.

1.2 Objectives and Tasks

There are two major objectives that were accomplished in this study. The first objective was to become familiar with using GT-Power as an engine development tool. The second objective was to understand the factors that were important for engine power improvement. In order to accomplish the goal and objectives of this report, there were three major tasks:

- Build a model in GT-Power that matched the published performance data for the MZ360 and use it as a base model
- Increase the displacement and extend the speed range of the base model to make a power improvement model
- Investigate a wide range of factors that improve the power output of the new engine to meet the final power target

2 Theoretical Power Improvement

Before the GT-Power model was developed, calculations were performed to determine the theoretical power output of the engine using basic engine parameters such as bore, stroke, air-fuel ratio, volumetric efficiency, and fuel conversion efficiency. Since the displacement and test conditions were established, the air flow rate at each engine speed was able to be calculated, as shown in Equation 2.1.

$$\dot{m}_a (kg/s) = \frac{n_v \times \rho (kg/m^3) \times V_d (m^3) \times N (rev/s)}{2} \quad (2.1)$$

The volumetric efficiency was unknown, so it was swept from 100% down to 50% to determine the impact on air flow. The intake air density was computed assuming an intake air temperature of 25°C and a pressure of 101 kPa. Once the air flow rate was known, the fuel flow rate was calculated assuming an AFR of 14.7, as shown in Equation 2.2. Stoichiometric air-fuel ratio of gasoline was used, instead of actual operation (12.5). An AFR of 12.5 would over-estimate the actual fuel burned in the cylinder.

$$\dot{m}_f = \dot{m}_a / AFR \quad (2.2)$$

Total fuel power supplied to the engine was computed by multiplying the fuel flow rate by the fuel lower heating value, assumed to be 44,000 kJ/kg. The theoretical power output of the engine was then calculated assuming 1/3 of the fuel power was converted to crankshaft power. The results of the calculations with different volumetric efficiencies are shown in Figure 2.1.

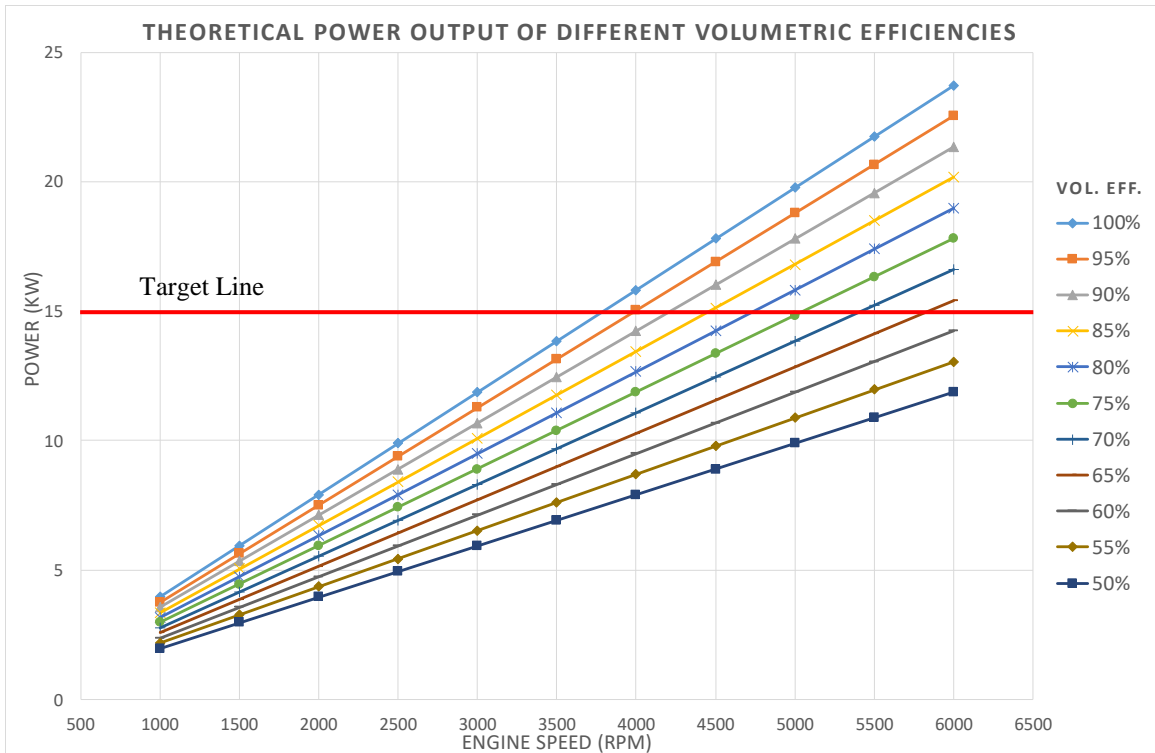

Figure 2.1: Theoretical power output of different volumetric efficiencies

With a target power output of 15 kW, the theoretical calculations showed that a minimum volumetric efficiency of 63% was required at 6,000 rpm. As engine speed decreases, volumetric efficiency must increase in order to reach the same target power output. For example, at 5,000 rpm, the volumetric efficiency must be at least 75% to theoretically produce 15 kW of power at the crankshaft.

3 Base Engine Modeling

3.1 Background Information

A Yamaha MZ360 engine was chosen in order to build a base model to tune several of the parameters in GT-Power. The two primary parameters of interest were the flame speed multiplier and the heat transfer multiplier. The engine is shown in Figure 3.1.



Figure 3.1: Yamaha MZ360 (base engine)

This engine was similar in displacement and features for the final engine. There was no actual engine used for measurements or collecting data. In order to collect the specifications required to build the model, data was found using multiple websites, the engine user's manual, and information that Yamaha provided. The base model was built and verified with the data collected.

3.1.1 Engine Specifications and Output

The MZ360 engine specifications are shown in Table 3.1.

Table 3.1: Base engine specifications

Parameter	Value
Bore x Stroke	85 mm x 63 mm
Displacement	357 cc
Compression Ratio	8.1:1
Max Power (Net)	7.6 kW (10.4 PS) @ 3600 rpm
Max Torque (Net)	23.9 Nm (17.6 ft-lbf) @ 2400 rpm
Fuel delivery	Carburetor
Spark timing	Fixed
Fuel	Gasoline

The engine performance curves for torque, power, and fuel consumption were obtained from the product page on the internet and are shown in Figure 3.2.

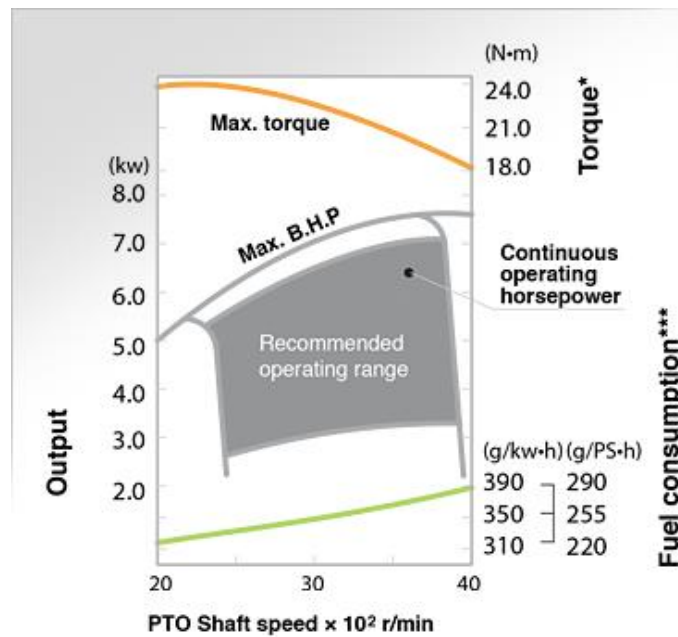

Figure 3.2: Base engine performance curves

Actual numbers were not provided on the curves so data was collected by drawing grids on the figure and reading the nearest number, as shown in Table 3.2. The power, torque, and brake specific fuel consumption (BSFC) at each engine speed were used in the validation part of the model.

Table 3.2: Base engine performance data extracted from published curves

Speed (RPM)	2000	2500	3000	3500
Torque (N•m)	23.9	23.5	22.7	21
Power (kW)	5	6.2	7.1	7.4
BSFC (g/kW•h)	320	335	350	370

3.1.2 Intake System Design

The base engine parts manual [3] displayed the parts required to build the intake system, which is shown in Figure 3.3. The manual did not provide the diameter and length of the components used in the intake system, so the sizes of the parts were assumed based on prior experience with similar engines.

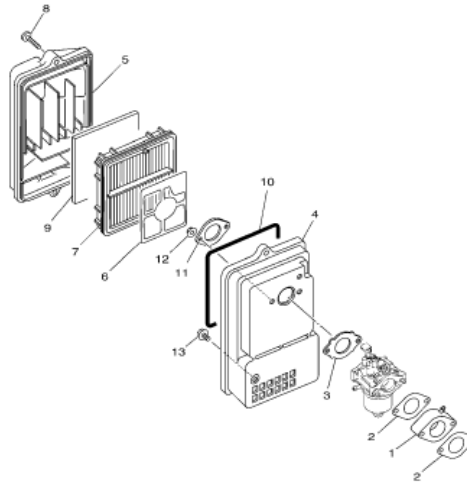

Figure 3.3: Base engine air filter, carburetor, and intake manifold

Critical dimensions of the carburetor were important as wrong settings would cause a difference in the model output. One of the online parts sellers [4] provided very detailed pictures of the inside diameters of the carburetor, which are shown in Figure 3.4.



Figure 3.4: Base engine carburetor dimensions from online retailer

The throat diameter of the carburetor was set as 16.5mm, as shown in Figure 3.5. The length of each part was set by measuring another engine's carburetor and rounding to some integer close to the measurement. A detailed sketch of the final carburetor layout for the engine simulation is shown in Figure 3.5.

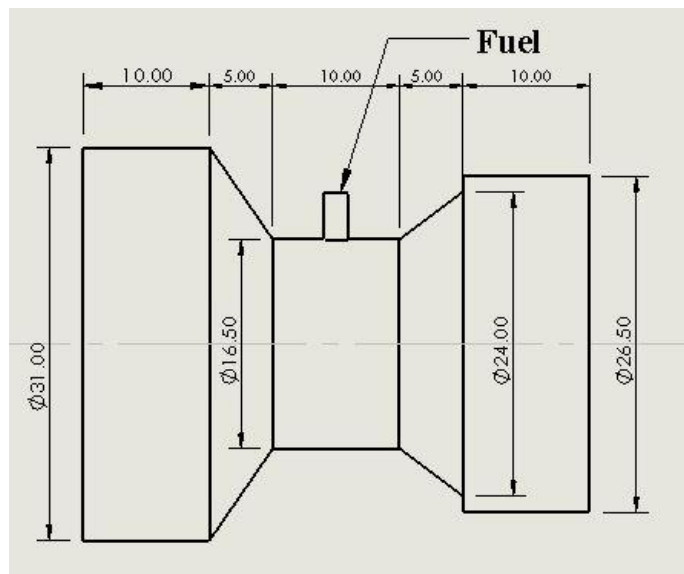

Figure 3.5: Base engine carburetor schematic for simulation

The carburetor was modeled as a collection of shapes because GT-Power does not have a carburetor component. The fuel delivery was modeled using a fuel injector, located at the throat of the carburetor. It was assumed that the air to fuel ratio was constant. The air flow rate at the inlet to the carburetor was used to compute the required fuel to reach the target AFR. Indolene was used as the fuel in the model.

3.1.3 Cam Profile and Valve Discharge Coefficient

Yamaha provided the cam lift and duration data for the base engine but due to confidentiality of the information, the data was not shown in the report. Discharge coefficient is the ratio of actual mass air flow rate past the valve to the theoretical flow past the valve. It is commonly used to evaluate how efficient the air flows past the valve. In order to run the simulation, the valve discharge coefficient was also required. Since such data was not provided for this engine, another set of data was used as a substitute. This set of data came from a reference paper [5] measuring a 407cc engine which was a reasonable approximation to the base engine. The displacements were not significantly different and the valve diameters are quite similar. Figure 3.6 shows the 407cc engine data discharge coefficients for both intake and exhaust.

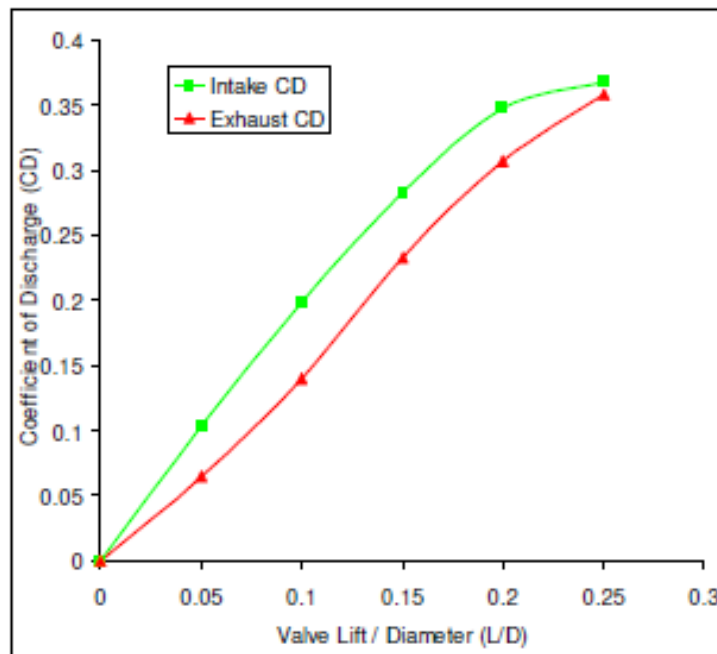

Figure 3.6: Reference intake and exhaust valve discharge coefficients

The discharge coefficients were collected from the reference paper [4] using a L/D interval of 0.025. The exhaust was further extended to 0.275 since the maximum value of dividing the actual exhaust valve lift to exhaust valve diameter for the base engine was 0.26. The

value of CD at that point was assumed that CD doesn't increase much for L/D value above 0.25. The data used in the model is shown in Figure 3.7.

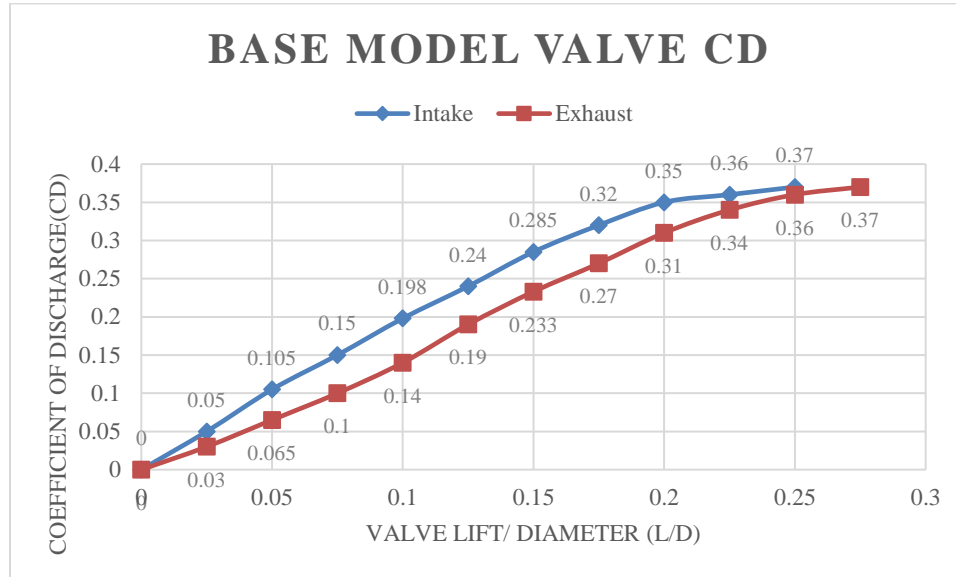

Figure 3.7: Base model intake and exhaust valve discharge coefficients

3.1.4 Volumetric Efficiency Calculation

Since power and BSFC were known from the published data, volumetric efficiency was calculated and used to assist with validating the GT-Power model. Volumetric efficiency is a good indicator of model accuracy. The calculation followed the formulas listed below:

Fuel flow rate (\dot{m}_f) was calculated from known power and BSFC.

$$\dot{m}_f = P \times BSFC \quad (3.1)$$

Air flow rate (\dot{m}_a) was calculated from fuel flow rate and assumed air-to-fuel ratio. Carbureted engines in this category typically run rich of stoichiometric. An AFR of 12.5 was used to compute the air flow.

$$\dot{m}_a = \dot{m}_f \times AFR \quad (3.2)$$

Volumetric efficiency (n_v) was calculated by using previous calculated numbers and air density, with a temperature of 298K and a pressure of 101kPa.

$$n_v = \frac{2 \times \dot{m}_a (\text{kg/s})}{\rho (\text{kg/m}^3) \times V_d (\text{m}^3) \times N (\text{rev/s})} \quad (3.3)$$

The calculated BSFC values at each engine speed are shown in Table 3.3.

Table 3.3: Base engine volumetric efficiency

Speed (RPM)	2000	2500	3000	3500
Power (kW)	5	6.2	7.1	7.4
BSFC (g/kW•h)	320	335	350	370
\dot{m}_f (g/min)	0.0267	0.0346	0.0414	0.0456
\dot{m}_a (g/min)	0.3333	0.4327	0.5177	0.5704
n_v (%)	79.5	82.6	82.4	77.8

3.1.5 Turbulent Combustion Model

GT-Power provided two types of models for simulating combustion in spark ignition engines. One of them was non-predictive, the SI Wiebe combustion model. This model required more data from the actual engine such as combustion phasing (CA50) and combustion duration (D10-90). The data would be acquired by actually running the engine, but since it was not available, a more predictive combustion model was utilized. The predictive model was the SI turbulent flame model, which required the combustion chamber design and tuning of parameters to produce accurate results. For the combustion chamber geometry, the size of the cylinder was known, but the cylinder head shape was not provided. Cylinder head was assumed to be flat in the model based on previous experience with engines of this type and displacement, it won't affect the results much. The primary tuning parameter for the turbulent combustion model was the flame speed multiplier. It affected the overall duration (D10-90) and the location of combustion (CA50). More detailed effects are compared in the validation part of this report.

3.1.6 Heat Transfer Multiplier

The heat transfer model in the 1-D cycle simulation requires a tuning parameter to improve the heat transfer results. As the flame speed is modified, the heat transfer must also be modified, in order for the power, BSFC, and volumetric efficiency values to match the published data. While the flame speed multiplier was effective at improving the model fit at higher engine speeds, the heat transfer multiplier was used to improve model results at lower speeds. Lower speeds provided more time for heat transfer and thus, the turning of the heat transfer multiplier was more effective in this operational regime. The effect of tuning data was discussed in the validation part of this report.

3.2 GT-Power Model of Base Engine

The base engine model was constructed by using the specifications provided publicly and applying the previously mentioned assumptions. Base engine specifications are shown in Table 3.4.

Table 3.4: Base engine GT-Power model specifications

Parameter	Value
Bore (mm)	85
Stroke (mm)	63
Compression ratio	8.1:1
Intake valve diameter (mm)	32
Exhaust valve diameter (mm)	28
Carburetor inside diameter (mm)	16.5
Spark timing (degrees BTDC)	15°

Air-fuel ratio	12.5:1
Fuel	Indolene

The model consists of the intake system starting from the air cleaner to the engine block and finally the exhaust system which ends at the exhaust pipe. The GT-Power model is shown in Figure 3.8.

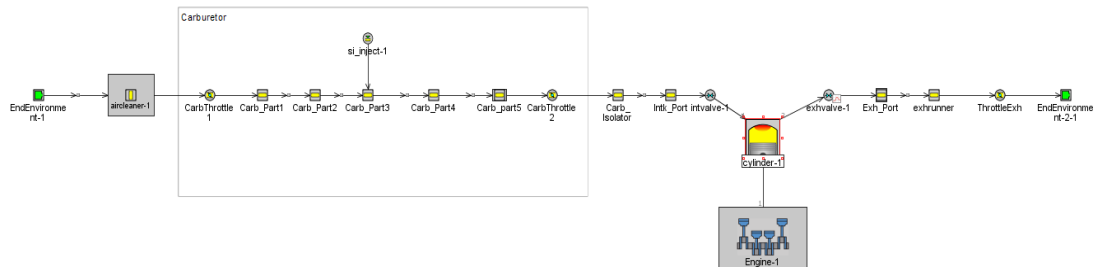

Figure 3.8: Base engine GT-Power model

3.2.1 Exhaust Back Pressure

The model was built with a throttle as a butterfly valve in the exhaust system to simulate the effect of exhaust back pressure caused by the muffler in the actual engine. A Kohler Command Pro CH395 engine [6] had a similar displacement and intake/exhaust valve configuration as the base model so the same exhaust back pressure limit was applied to the base engine model. Kohler listed the exhaust back pressure of 30 inches of water which equals 0.075 bar so the back-pressure target value for the model was set at 1.075 bar absolute at 3500 rpm.

To determine the butterfly valve setting to reach this value in the model, the Optimizer in GT-Power was applied and found the correct opening angle. The butterfly valve angle was set as the independent parameter and the pressure at that point was set as the dependent variable. The target was set as mentioned above with a 5% tolerance. A butterfly valve angle of 51° opening gave the closest result and is shown in Figure 3.9.

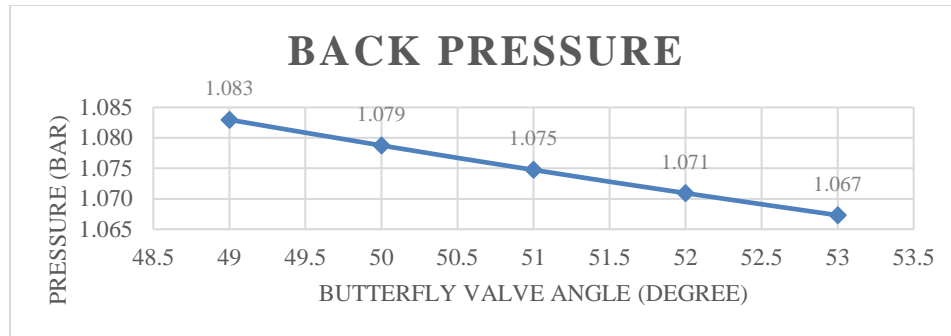

Figure 3.9: Exhaust butterfly valve angle and effect on exhaust back-pressure

3.2.2 Model Assumptions

In order to build the base engine model, the following assumptions were made:

1. Initial air conditions set at 25° C and 1 bar absolute
2. Cylinder head: flat geometry
3. Intake and exhaust system lengths were assumed based on previous experience
4. Heat Transfer Multiplier (HTM) set to 1.0 (default)
5. Flame Speed Multiplier (FSM) set to 1.0 (default)
6. Exhaust back pressure set to 1.075 bar absolute
7. AFR = 12.5:1

3.2.3 Base Engine Model Performance

The simulation performed with the initial settings showed that the model was over-predicting the performance compared to the actual engine, as shown in Figure 3.10. The over-estimated volumetric efficiency led to over-estimated power and torque which also caused the under-estimated BSFC. Further adjustment to the model tuning parameters was required to match the known and calculated data points from the actual engine.

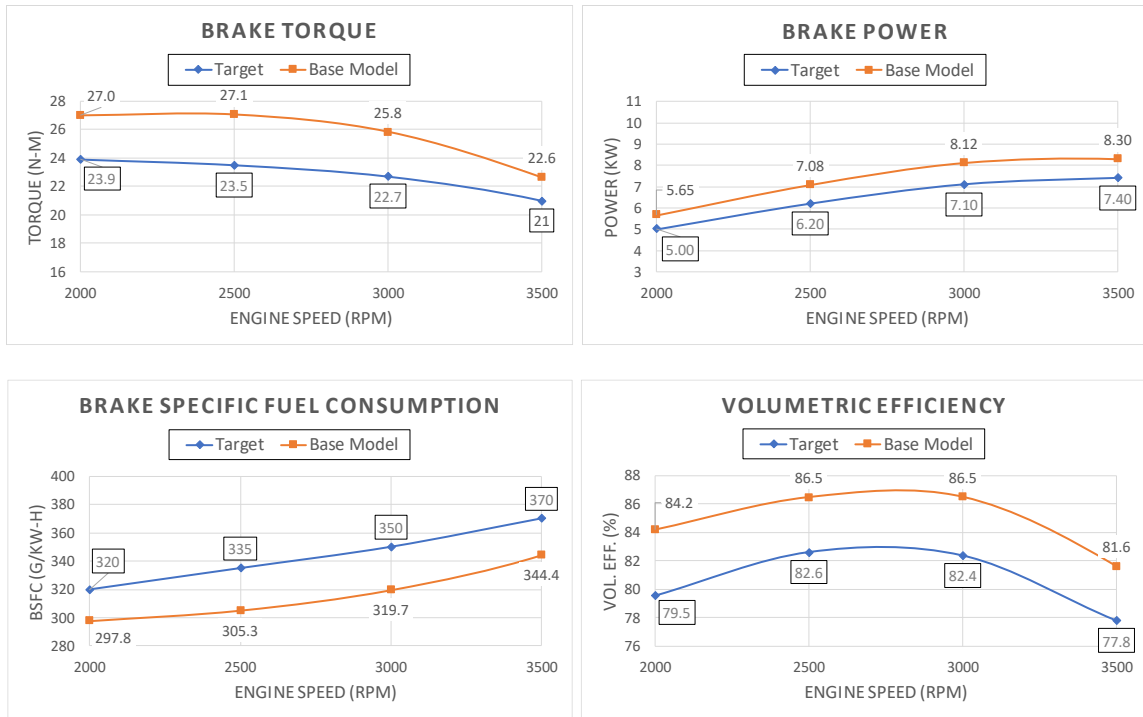

Figure 3.10: Base engine model output with no parameter tuning

3.3 Base Engine Model Tuning and Validation

Three parameters were modified to improve the simulation output and reach the target values. They were the flame speed multiplier, the heat transfer multiplier, and the air-fuel ratio.

3.3.1 Effect of Flame Speed Multiplier (FSM)

Lowering the FSM decreased the combustion speed and lowered the power output. As shown in Figure 3.11, the effect of decreasing the FSM increased as the engine speed increased. In order to maintain enough power at 3500 rpm but still reduce the lower speed power, the FSM was set at 0.85. This was a 15% decrease of the default setting (1.0).

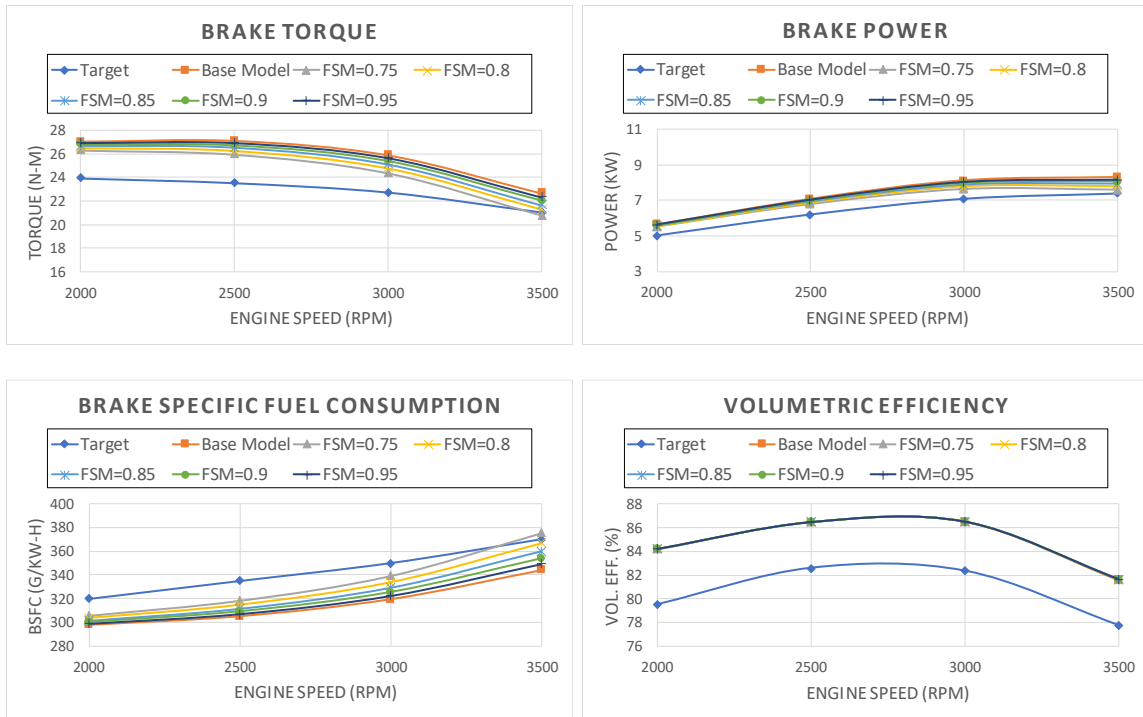

Figure 3.11 Effect of FSM on torque, power, BSFC, and volumetric efficiency

3.3.2 Effect of Heat Transfer Multiplier (HTM)

Modification of the FSM was not enough to sufficiently improve the simulation output. The model was still over predicting the torque, power, and volumetric efficiency. Therefore, the heat transfer multiplier was modified to improve the model. By increasing the HTM, the power at lower speeds decreased but had a minimal effect at higher engine speed, as shown in Figure 3.12. The values of torque and power were closer to the target values after increasing the HTM. However, the BSFC was not matched well at high and low ends and the volumetric efficiency was still over-predicted. A further step was required to improve the model.

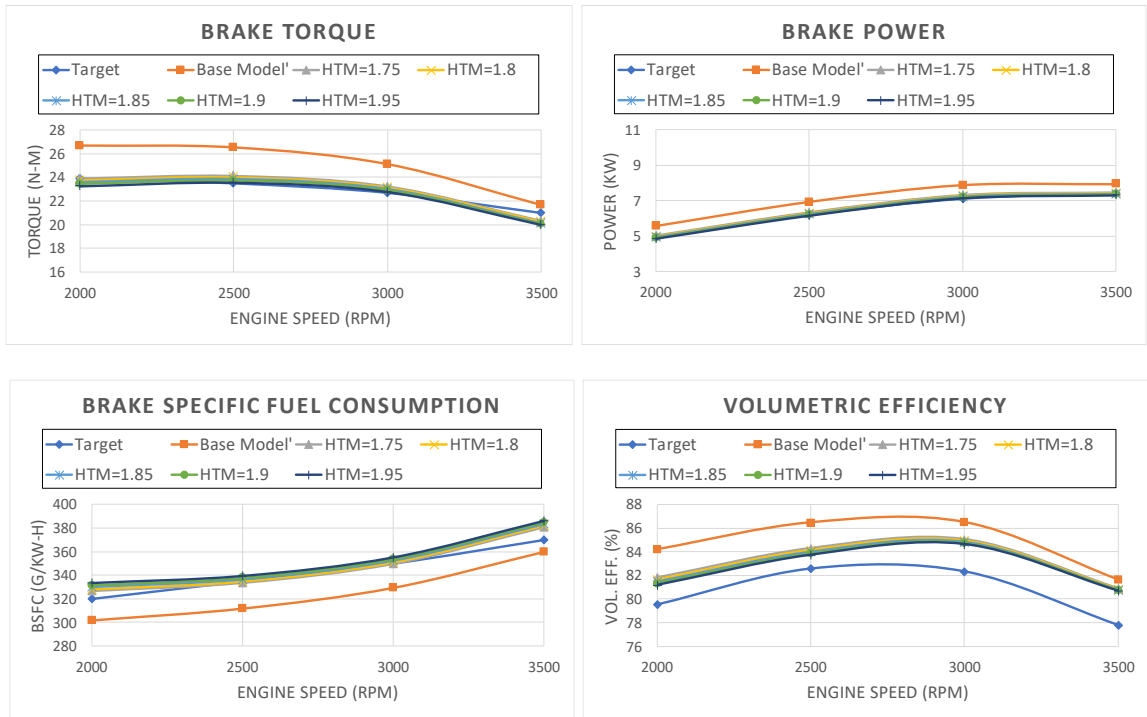
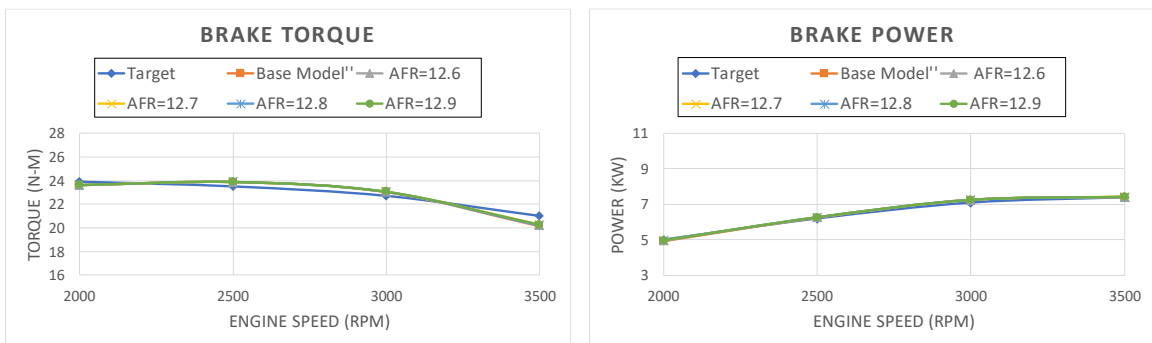

Figure 3.12: Effect of HTM on torque, power, BSFC, and volumetric efficiency (Base Model' had FSM set at 0.85)

3.3.3 Effect of AFR

BSFC was directly impacted by AFR, because it changed the amount of fuel delivered to the engine, at different engine speeds. The effect on power and torque was not obvious since the AFR only changed slightly. An increase in AFR resulted in a reduction in BSFC as shown in Figure 3.13.



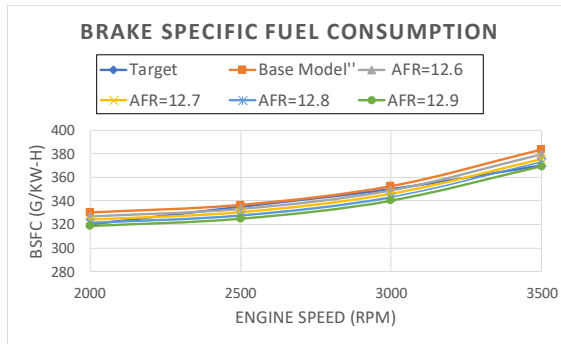

Figure 3.13: Effect of AFR on torque, power and BSFC
(Base Model'' had FSM set at 0.85 and HTM set at 1.85)

It was necessary to compute the volumetric efficiency with the new AFR to see the effect of changing AFR on volumetric efficiency. The effect of AFR is shown in Figure 3.14. From the figures showing BSFC and volumetric efficiency comparison, an AFR of 12.7 provided the best result for both factors.

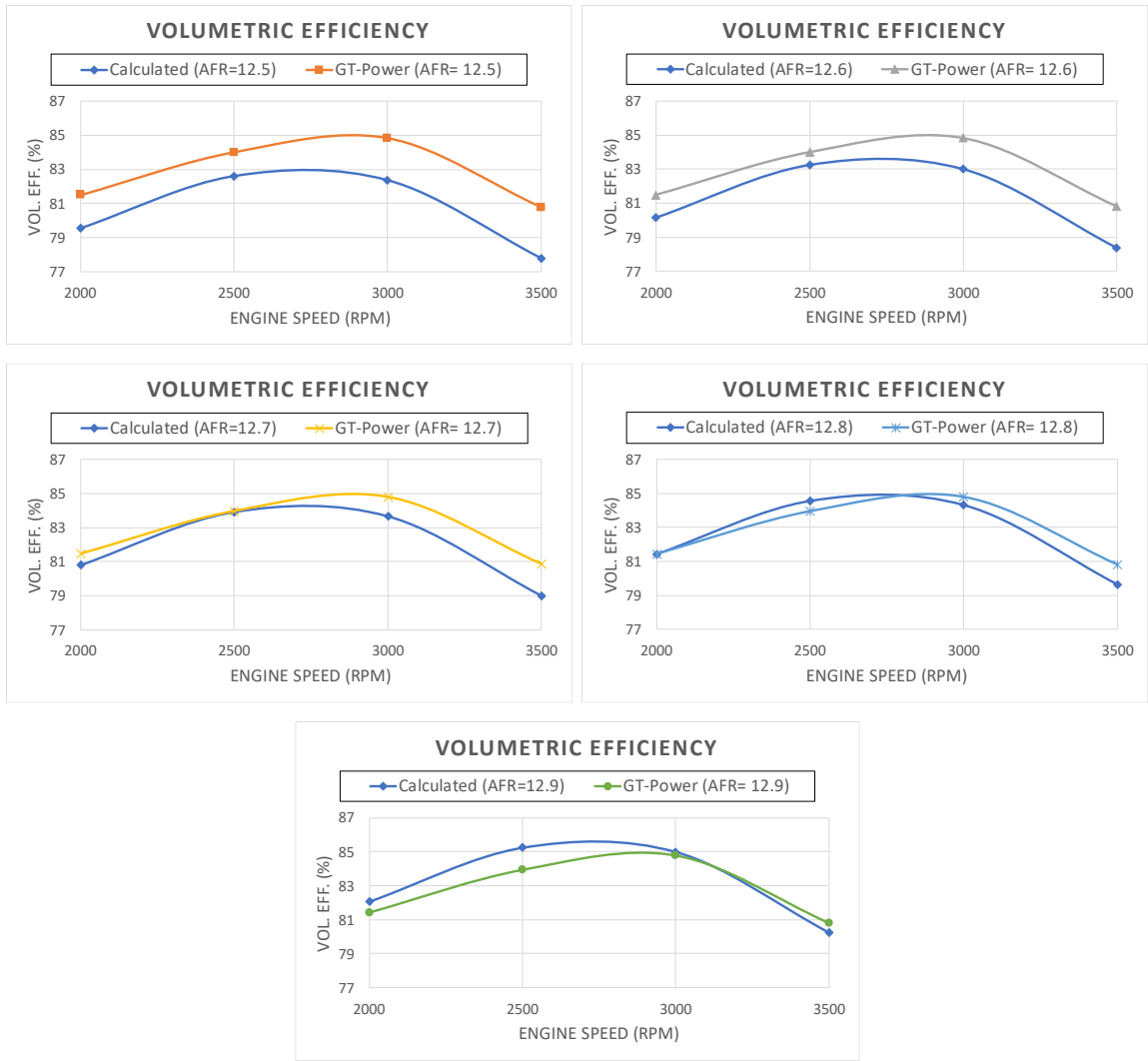

Figure 3.14: Effect of AFR on volumetric efficiency

3.4 Final Model for Base Engine

The angle of the exhaust throttle (butterfly valve) had to be changed due to the modifications applied to FSM, HTM and AFR. Each of these affected the exhaust back pressure. The four modifications applied to the initial settings of the base model are listed below:

1. FSM: $1 \rightarrow 0.85$

2. HTM: 1 → 1.85
3. AFR: 12.5:1 → 12.7:1
4. Exhaust butterfly valve open angle: 51° → 49°

The final results for the base engine model are shown in Figure 3.15. The model showed satisfactory prediction of engine performance after the four parameters were modified. This was used as the starting point for the new engine model that would be used to study the options for the power increase.

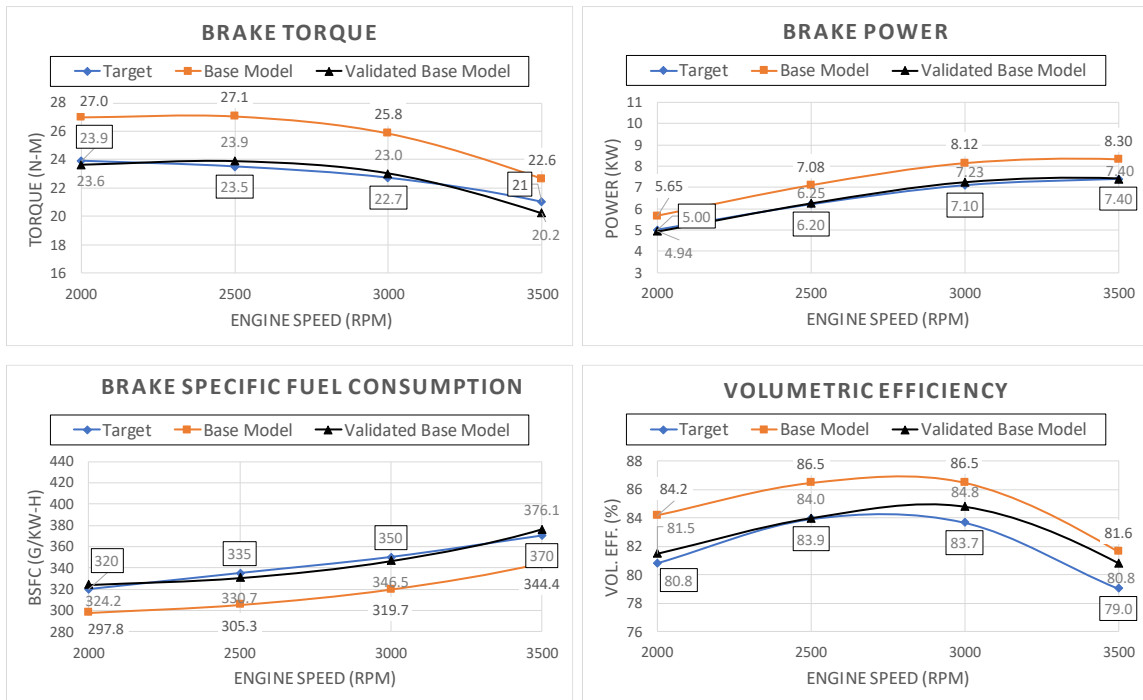

Figure 3.15: Final performance data comparison for base engine model

4 Power Improvement Engine Modeling

From the theoretical power output solutions, it was known that the power improvement model could reach the power target if volumetric efficiency values could be met. In addition, the fuel conversion efficiency would need to be around 33% to reach the power target. When running the new model, the tuning parameters from the base model were not changed, as it was assumed the HTM, FSM, and AFR would not be affected by the new engine.

4.1 Power Improvement Model

Several parameters within the power improvement model were modified for the first iteration, which attempted to minimize the engine changes to keep costs low. As shown below, the overall displacement and compression ratio both increased, and the carburetor was changed to a larger size.

1. Carburetor throat diameter: 16.5mm → 21mm
2. Bore: remained the same as base engine
3. Stroke: 63mm → 71mm
4. Compression ratio: 8.1:1 → 8.2:1

The performance of the power improvement model is shown in Figure 4.1. It can be noted that the power is negative after 5500 rpm due to the lack of air flow. This is a direct indicator that it requires a work input to the crankshaft to get the engine to operate above 5500 rpm. The very high BSFC value after 5000 rpm indicates incomplete combustion. The combustion event was still occurring when the exhaust valve opens. Also note the very late combustion phasing (CA50) as engine speed increased, due to the fact that the spark timing was fixed at 15° BTDC. A typical CA50 for best fuel conversion efficiency is around 8° ATDC. The volumetric efficiency of the engine also dropped down dramatically after 3500 rpm. This would become the limitation for further power improvements.

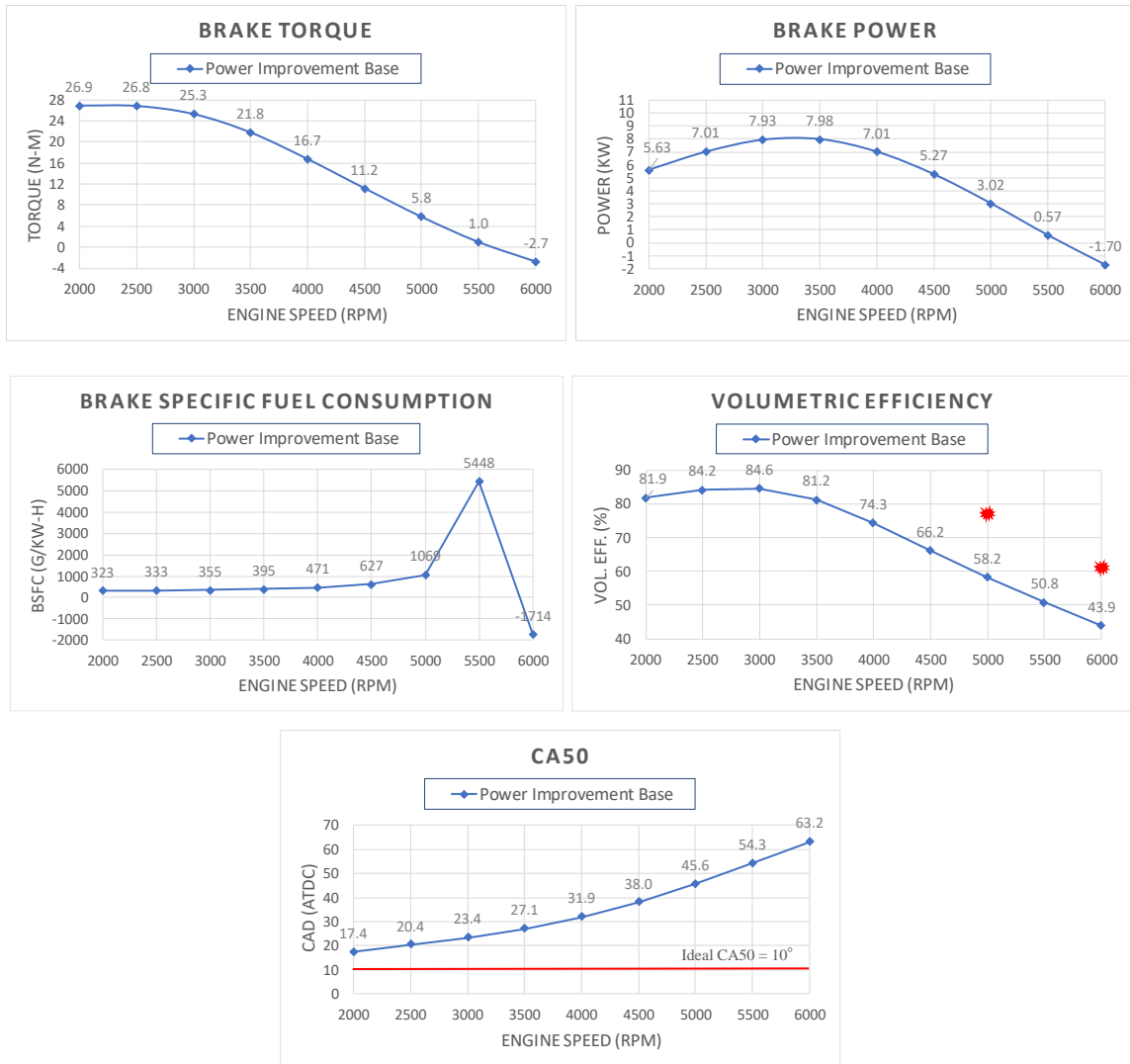

Figure 4.1: Power improvement base model performance (* Theoretical volumetric efficiency for 15kW)

4.2 Improvement Tests

In order to increase the performance and try to reach the target power of 15 kW at 6000 rpm, it was obvious that some changes to the model were required. The following factors were modified to determine the effect on the power output:

1. Spark timing

2. Carburetor diameter
3. Compression ratio
4. Exhaust back pressure
5. Camshaft timing, duration, and lift

4.2.1 Effect of Spark Advance

Advancing the spark timing was believed to have a direct impact on power output due to the fact that the combustion event was not completed when the exhaust valve opened at higher engine speeds. The original setting of the spark timing was fixed at -15° ATDC. The Optimizer in GT-Power was used and a target value of CA50 at each speed was set to 15° ATDC by changing the spark timing. Figure 4.2 shows that by optimizing the spark timing at each engine speed, the target CA50 could be reached and the combustion event was finished before the exhaust valve opened.

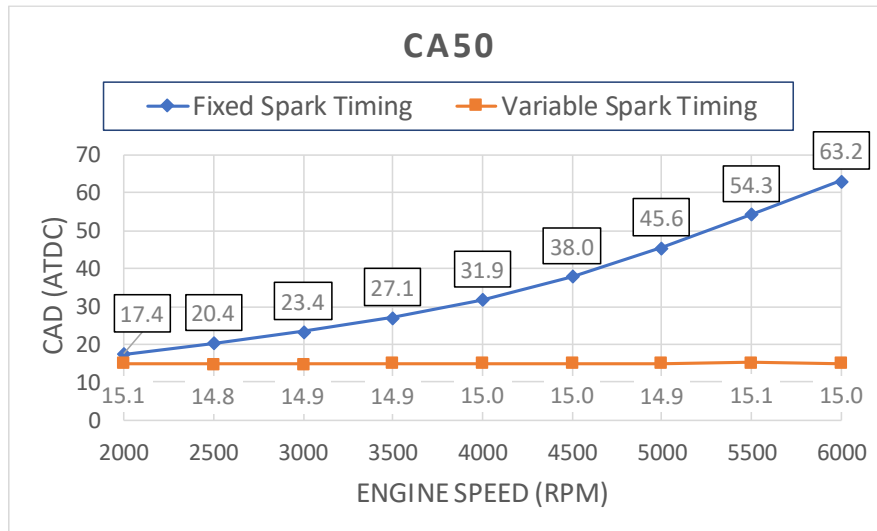

Figure 4.2: CA50 of fixed and variable spark timing

The power at the higher engine speeds became positive with spark advance but was still significantly below the target value due to the low volumetric efficiency. This result is shown in Figure 4.3. Further modifications to the model, to improve power output at higher engine speeds, focused on improving volumetric efficiency. The effect of proper

combustion phasing was critical at higher engine speeds and the following modifications required the use of the optimizer to reach the same CA50 value for each of the test runs.

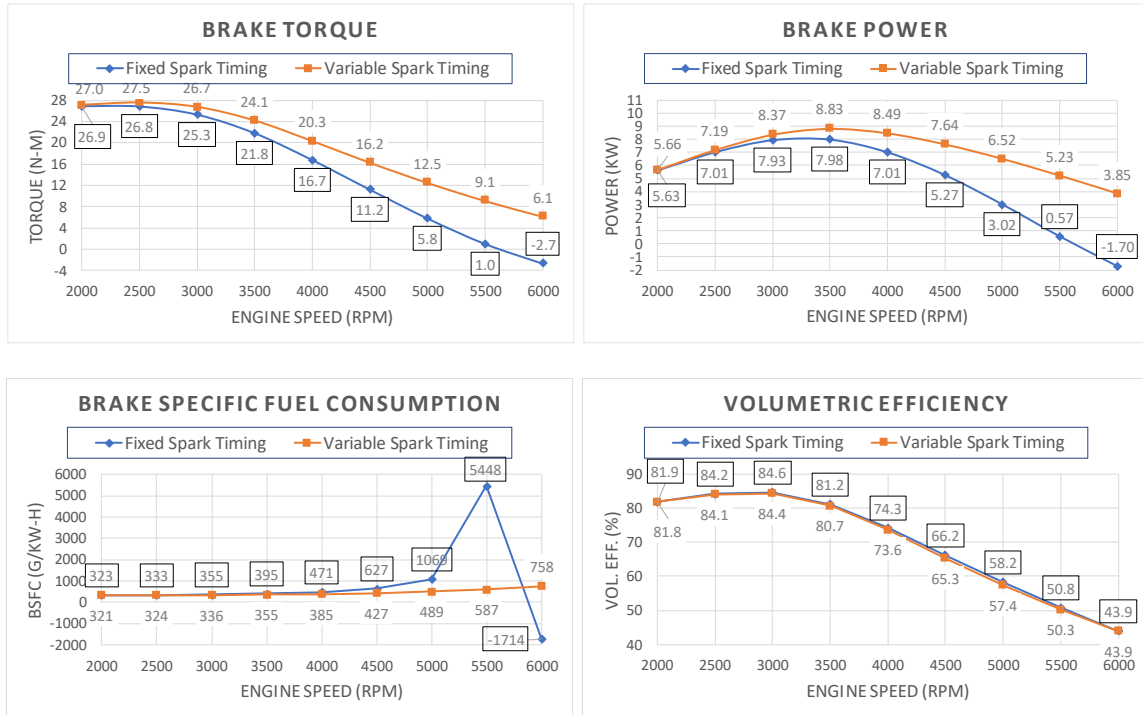

Figure 4.3: Effect of spark advance on torque, power, BSFC, and volumetric efficiency

4.2.2 Effect of Compression Ratio

Increasing the compression ratio rises the cylinder pressure at top-dead-center which enhances the power output of the engine. Starting at a compression ratio of 8.2, it was increased to 8.5, 9, and 9.5. It was believed that above 9.5, operation on 87 octane fuel may result in auto-ignition. Figure 4.4 shows a slight increase in power as compression ratio increased, but the primary issue with lower power output still remained the low volumetric efficiency.

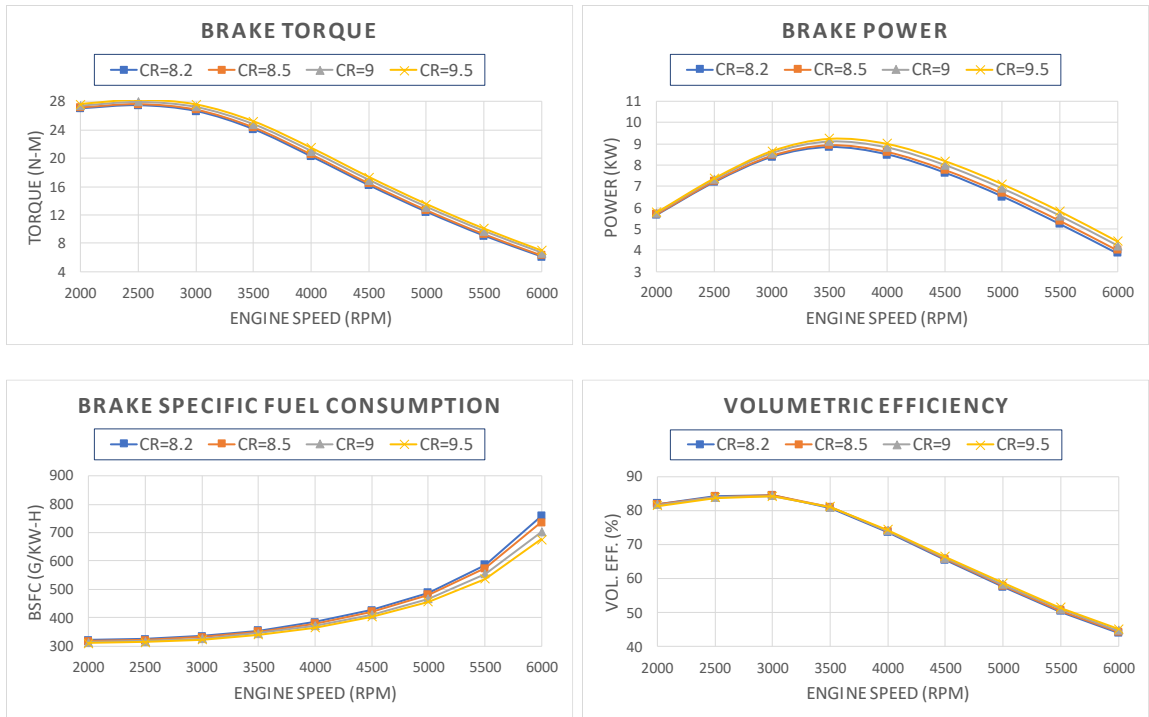
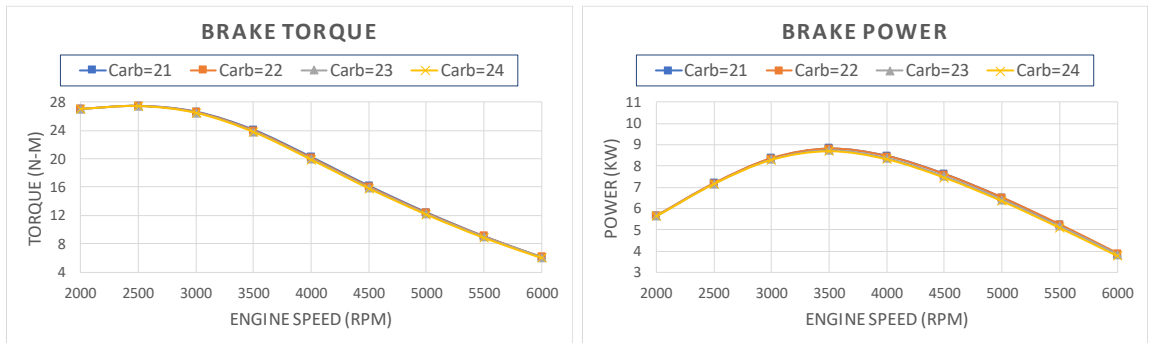

Figure 4.4: Effect of compression ratio on torque, power, BSFC, and volumetric efficiency

4.2.3 Effect of Carburetor Diameter

The carburetor diameter was increased by 1mm, 2mm, and 3mm to study the impact on engine performance. As shown in Figure 4.5, there was nearly no effect on torque, power, BSFC, or volumetric efficiency with increasing the carburetor diameter. It was determined that the carburetor was not the primary cause of the low volumetric efficiency as engine speed increased.



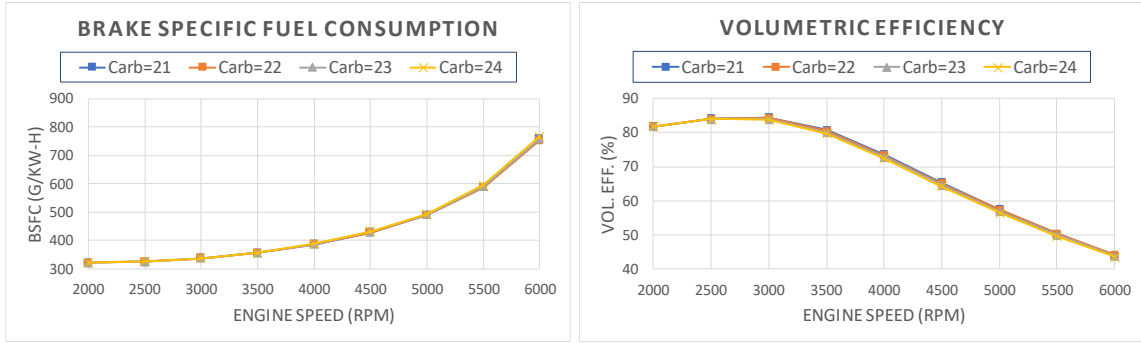

Figure 4.5: Effect of carburetor diameter on torque, power, BSFC, and volumetric efficiency

4.2.4 Effect of Exhaust Back Pressure

The exhaust butterfly valve angle was set at 100% open in order to study the effect of decreasing exhaust back pressure on volumetric efficiency. Figure 4.6 shows that once the butterfly valve was fully opened, the exhaust pressure at 3500 rpm became close to atmospheric pressure (1 bar).

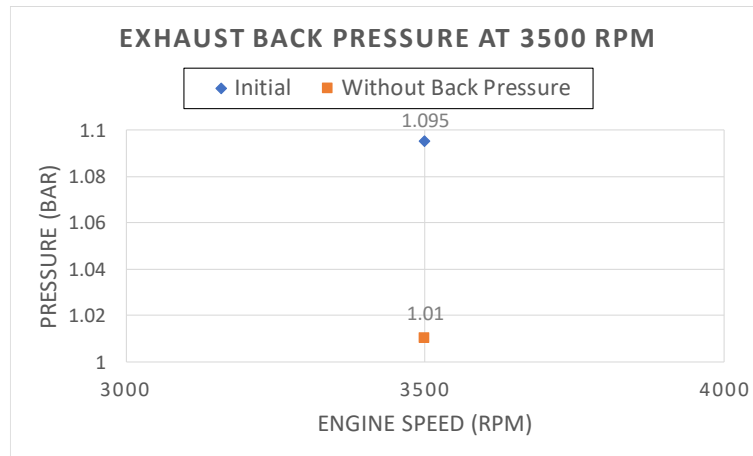

Figure 4.6: Exhaust back pressure at engine speed of 3500 rpm

As shown in Figure 4.7, there was a slight increase in volumetric efficiency due to the lower restriction in the exhaust system, which resulted in a slight increase in power. Because the change in exhaust pressure did not significantly increase volumetric efficiency,

the remaining tests used the previous exhaust butterfly valve setting so the effect of a muffler was included in the final model results.

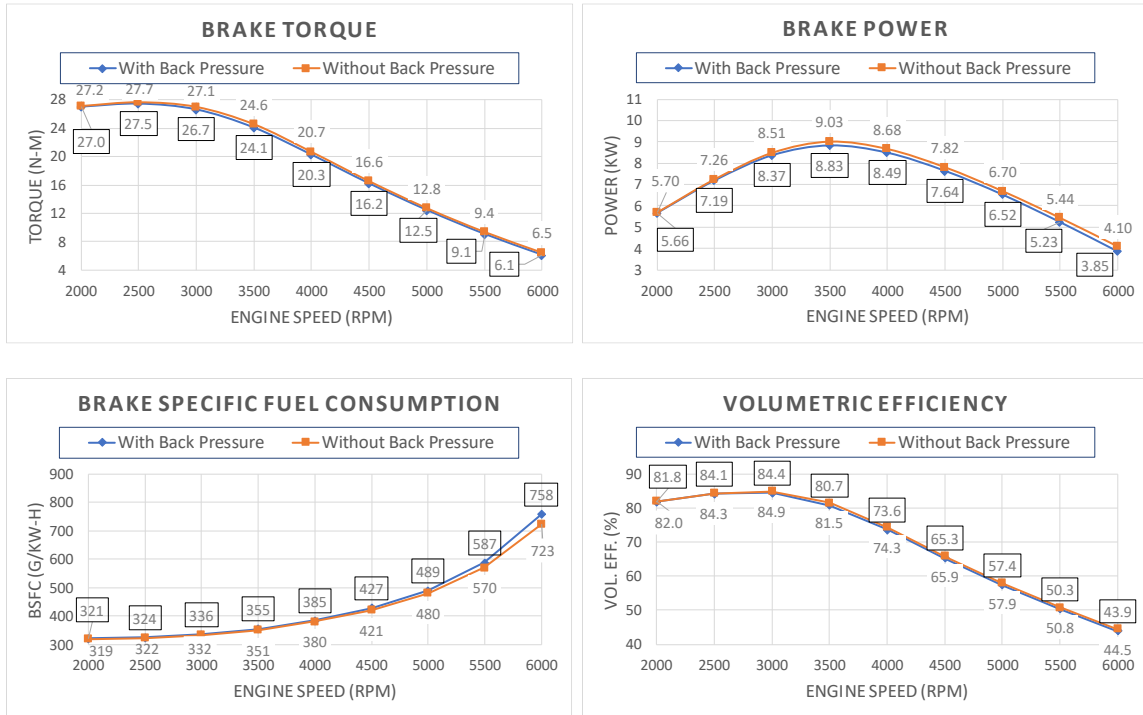

Figure 4.7: Effect of exhaust back pressure on torque, power, BSFC, and volumetric efficiency

4.2.5 Effect of Cam Timing

Cam timing directly affects the air flow in and out of the engine and thus impacts the volumetric efficiency. Figure 4.8 shows how the cam timing was shifted to perform the study. Various cam timing settings were evaluated by shifting the maximum lift location of the intake cam, the exhaust cam, or both cams together to study the effect.

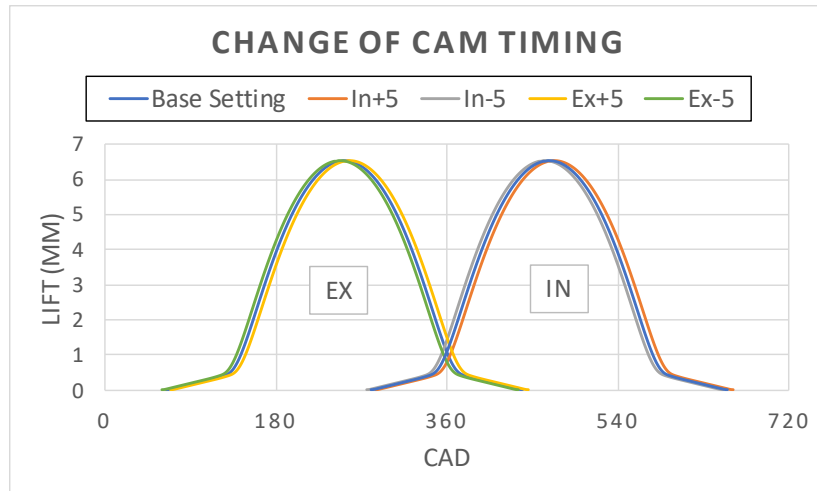

Figure 4.8: Cam timing settings

Retarded cam timing is shown as a positive change and advanced cam timing is shown as a negative change. Figure 4.9 shows that by changing the original cam setting to either a retarded intake or exhaust had a positive effect on the volumetric efficiency and thus power output at higher engine speeds.

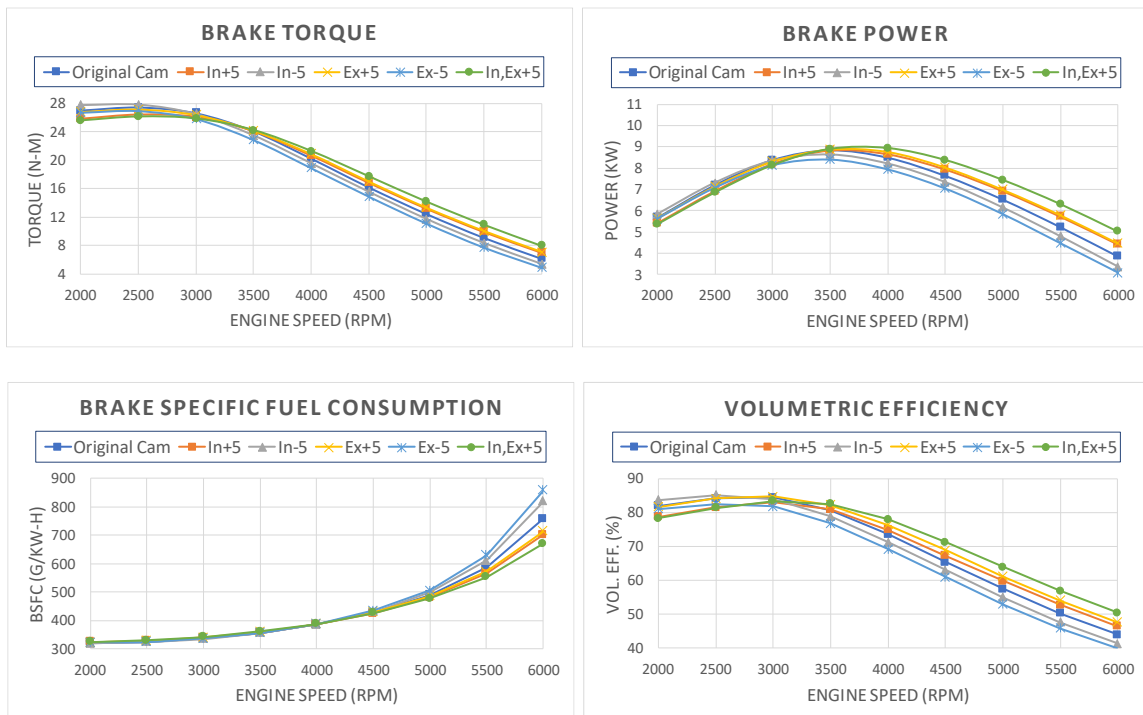

Figure 4.9: Effect of cam timing on torque, power, BSFC, and volumetric efficiency

4.2.6 Effect of Cam Duration

Extending the overall cam duration increases the area of the cam lift profile, which increases the air flow at higher speeds. In this test, the cam duration multiplier in GT-Power was increased 5% and 10% to extend the duration of both the intake and exhaust valves which is shown in Figure 4.10.

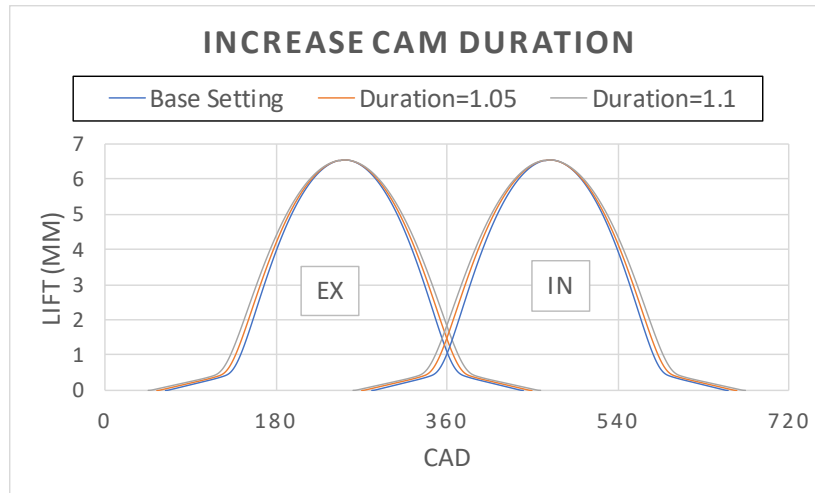
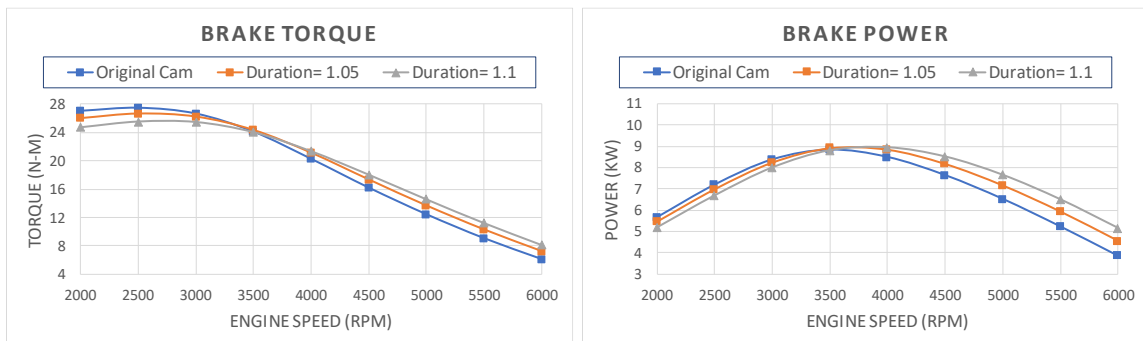

Figure 4.10: Cam duration settings

Figure 4.11 shows that extending the duration increases the volumetric efficiency at higher engine speeds, and thus also enhances the power output. However, extended cam duration lowers the volumetric efficiency at low engine speeds since the intake and exhaust are both open longer and thus, the air could have been pushed out of the cylinder during the compression stroke.



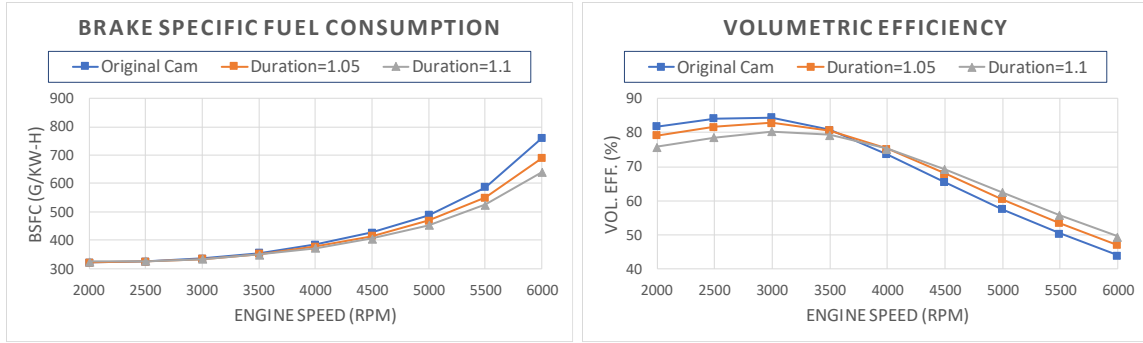

Figure 4.11: Effect of cam duration on torque, power, BSFC, and volumetric efficiency

4.2.7 Effect of Valve Lift

Increasing the valve lift increases the area available for the air to enter or exit the engine. The limit on valve lift was to avoid the valves from hitting the piston near top-dead-center. The valve lift multiplier in GT-Power was increased from 1.13 to 1.18 and 1.2, which is shown in Figure 4.12.

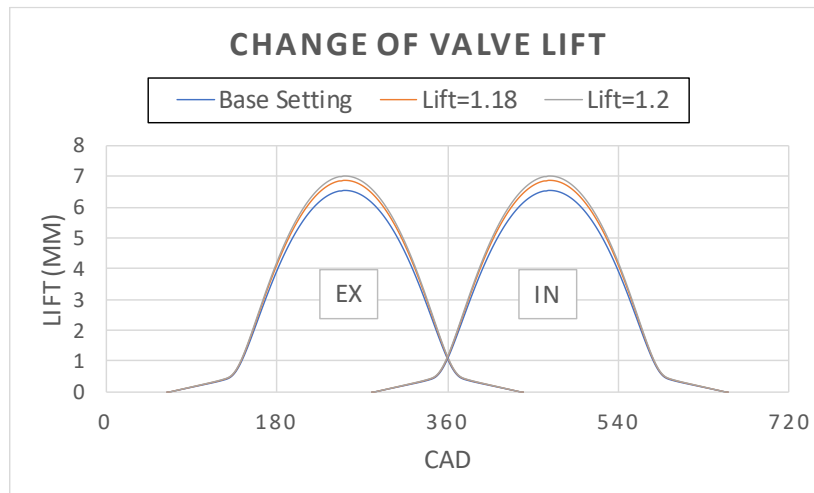

Figure 4.12: Valve lift settings

Figure 4.13 shows that there would be an obvious increase of the volumetric efficiency at higher engine speed with increased valve lift. This would be beneficial for the increase of engine power.

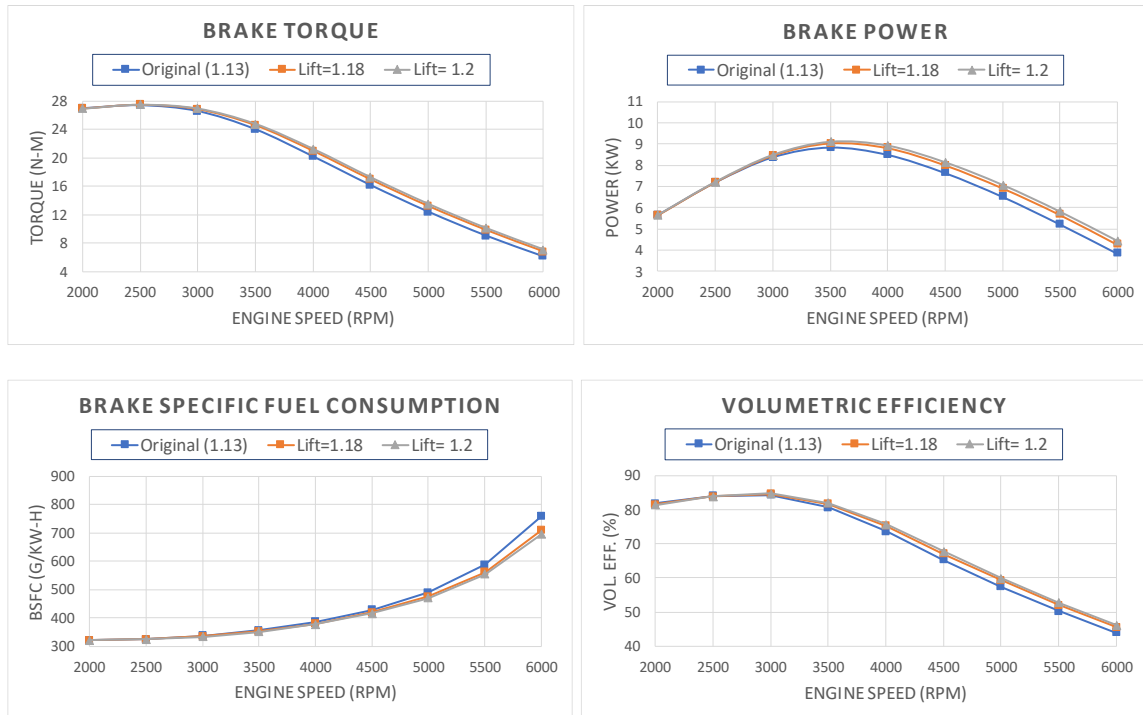

Figure 4.13: Effect of valve lift on torque, power, BSFC, and volumetric efficiency

4.3 Final Model Performance

Different trials were examined by combining the effects of various ways that would improve the power of the engine. The best result found had the listed settings reaching a maximum power of 10.0 kW at 4000 rpm, as shown in Figure 4.14. An estimated improvement of 25% in power output compared to the base improvement model could be realized with the following modifications:

- Electronic spark advance with a CA50 target set to 15° ATDC at each engine speed
- Compression ratio increased from 8.2:1 to 9.5:1
- Exhaust back pressure minimized
- Shifting the intake cam phasing 5 degrees later than base model
- Stock exhaust cam timing
- Cam duration increased 5%
- Valve lift increased from 1.13 to 1.2

The final cam duration and cam phase settings applied was not the ones which gave the best results. This was because previously, the best result was obtained by examining the effects separately. Once by combining the effects, a decision was made to balance the improvement in power at higher engine speed with minimal loss in power at lower speed.



Figure 4.14: Power improvement best result performance

5 Conclusions and Future Work

GT-Power is a powerful software program which can provide predictions on power, fuel consumption, and combustion, before an actual engine is made. For this project, a base model was built and validated which represented the actual performance of the base engine. After validating the base engine simulation, an additional model was constructed by changing several parameters which includes increased displacement by extending the stroke, increased carburetor size, and compression ratio. These were believed to increase the power output of the engine in the modeling process.

The results were not as expected and the model only produced 0.58 kW of additional power compared to the base model. The two major problems found limiting the power were the late combustion timing at higher speeds and the low volumetric efficiency of the engine. After observing these issues, an improvement plan was developed and different solutions were tested. Considering the cost that a company might be willing to spend, setting changes were limited to parts which cost less for making changes. In this point of view, the effect of changing the carburetor, camshaft timing, adding variable spark timing, and the exhaust back pressure were examined. By combining changes which were positive for power increase, the maximum power output was 10.0 kW @ 4000 rpm. The target of 15 kW at 6000 rpm was not reached due to a significant reduction in volumetric efficiency as engine speed increased. Although the target power was not reached, the simulation results produced a 35% improvement compared to the base model (MZ360). The simulations were also able to provide some useful clues that the power limitation was still caused by low volumetric efficiency. If the lifetime of the engine was also considered, typically this type of engine provides reliable energy around 3000 hours. Even if running at 6000 rpm would cut off half of the operation hours, it could still operate 8 hours a day for approximately half of a year. This would still be a decent amount of lifetime compared to how much flexibility that could be further extended to the engine.

Since the discharge coefficient was referenced from a paper, there was a concern on whether it could represent the base model or not. If the stock cylinder head was provided and the CD could be measured using a flow bench, the model accuracy could be further improved. A possible way of improving volumetric efficiency would be an intake air pressure boost system. It was noticed that increased valve lift and modified cam timing provided more air flow to the engine. Additional modifications to the cam timing may produce additional power. 3D computational fluid dynamics simulation would provide information about the effect of changing engine head geometry such as valve angle or intake/exhaust port geometry. Changing from two valves to four valves in the head would provide more area for air flow and increase volumetric efficiency. Only by solving the air restriction issue would the engine be able to reach a higher power output.

6 Reference List

- [1] US Code of Federal Regulations, Part 1054
(https://www.ecfr.gov/cgi-bin/text-idx?SID=fc799a21d4ca6f413913715af7c09e88&mc=true&node=pt40.36.1054&rgn=div5#se40.36.1054_1107)
- [2] Yamaha MZ360 Multi-Purpose Engine Online Specifications
(<https://www.yamahamotorsports.com/multi-purpose-engine/models/mz360>)
- [3] Yamaha MZ360 Online Parts Manual
(<https://www.m-and-d.com/pdfs/Yamaha/MZ360%20Parts%20Manual.pdf>)
- [4] Yamaha MZ360 parts sale via AliExpress
(<https://www.aliexpress.com/item/GENUINE-MIKUNI-CARBURETOR-ASSY-FOR-YAMAHA-MZ300-MZ360-ENGINE-FREE-SHIPPING-BRAND-NEW-GENERATOR-CARB-OEM/32337206653.html>)
- [5] Abdul Rahim Ismail, Rosli Abu Bakar, (2008). An Investigation of Valve Lift Effect on Air Flow and Coefficient of Discharge of Four Stroke Engines Based on Experiment. doi: 10.3844/ajassp.2008.963.971
- [6] Kohler Command Pro CH 395 engine specifications
(<https://kohlerpower.com/en/engines/product/command-pro-ch395>)
- [7] Heywood, J. Internal Combustion Engine Fundamentals, 1998 (McGraw-Hill, New York)