



**Michigan
Technological
University**

Michigan Technological University
Digital Commons @ Michigan Tech

Dissertations, Master's Theses and Master's Reports

2015

Decomposing the blocks of a Steiner triple system of order $4v-3$ into partial parallel classes of size $v-1$

Leah C. Tollefson

Michigan Technological University, lctollef@mtu.edu

Copyright 2015 Leah C. Tollefson

Recommended Citation

Tollefson, Leah C., "Decomposing the blocks of a Steiner triple system of order $4v-3$ into partial parallel classes of size $v-1$ ", Open Access Master's Report, Michigan Technological University, 2015.
<https://doi.org/10.37099/mtu.dc.etdr/54>

Follow this and additional works at: <https://digitalcommons.mtu.edu/etdr>



Part of the [Discrete Mathematics and Combinatorics Commons](#)

DECOMPOSING THE BLOCKS OF A STEINER TRIPLE SYSTEM OF ORDER

$4v - 3$ INTO PARTIAL PARALLEL CLASSES OF SIZE $v - 1$

By

Leah C. Tollefson

A REPORT

Submitted in partial fulfillment of the requirements for the degree of

MASTER OF SCIENCE

In Mathematical Sciences

MICHIGAN TECHNOLOGICAL UNIVERSITY

2015

© 2015 Leah C. Tollefson

This report has been approved in partial fulfillment of the requirements for the Degree of MASTER OF SCIENCE in Mathematical Sciences.

Department of Mathematical Sciences

Report Advisor: *Dr. Melissa S. Keranen*

Committee Member: *Dr. Donald L. Kreher*

Committee Member: *Dr. Timothy C. Havens*

Department Chair: *Dr. Mark S. Gockenbach*

Dedication

To my mom and dad,

both of whom have unequivocally supported me every step of the way.

Contents

List of Figures	ix
Acknowledgments	xi
Abstract	xiii
1 Background and Introduction	1
1.1 Background	1
1.2 Introduction	6
2 Known Results and Methods	9
2.1 Known Results	9
2.2 MOLS and RGDDs	12
2.3 KT Designs	17
2.4 Main Lemmas	19
2.4.1 Case 1: $v \equiv 9 \pmod{12}$	23
2.4.2 Case 2: $v \equiv 3 \pmod{12}$	29
3 Conclusion and Future Work	35

References	39
A	43

List of Figures

1.1	The 7 blocks of an STS(7)	2
1.2	The 4 parallel classes and 12 blocks of a KTS(9)	3
1.3	A 3–RGDD of type 4^3	4
1.4	A Kirkman frame of type 2^4	6
1.5	A Kirkman frame of type 4^4	7
2.1	A Latin square of order 4	12
2.2	2 MOLS(3)	13
2.3	An OA(4, 3)	13
2.4	A TD(4, 3)	14
2.5	A KT(15; $2^7 3^3 4^3$)	19
2.6	A KT(21; $4^{10} 5^6$)	20
2.7	A 3–RGDD(5^3) parallel class on an inflated frame parallel class from a 3–frame of type 4^4	28
2.8	Type III PPCs from an STS(81)	29
2.9	A 3–RGDD(7^3) parallel class on an inflated frame parallel class from a 3–frame of type 2^4	33

2.10 Type III PPCs from an STS(57)	34
A.1 A KT(27; 2 ¹³ 6 ⁷ 7 ⁷)	44

Acknowledgments

My gratitude must be expressed for my advisor, Missy Keranen. Her guidance and support was paramount to my success. I would also like to thank my committee members: Don Kreher for his graph theory classes and advice with this research and Tim Havens for going out on a limb and agreeing to be on my committee. A big thank you to Dalibor Froncek for all of the help with my undergraduate research, for encouraging me to pursue graduate studies, and finally for entrusting me to the care of his son when I visited Bratislava. All of my office mates over the past two years also deserve praise for not only listening to my ceaseless stories, but also seeming to enjoy them: Ellen Kamischke, Fiona Yang, Elaheh Gorgin, and Teresa Woods. Thanks are also due to all of my friends here on campus and in the Keweenaw - we have had many an adventure and I am so glad to have met you all. To my friends afar, I thank you all for always knowing how to keep my spirits high. Finally, I give thanks to my mom, dad, Maddie, Ingrid, Jackson, and Ella for the unconditional love. Tusen takk for alt dere har gjort for meg.

Abstract

In this report we present a summary and our new results on finding partial parallel classes of uniform size of Steiner triple systems, $\text{STS}(v)$. We show several results for $\text{STS}(4v - 3)$, where $v \equiv 3 \pmod{12}$ and $v \equiv 9 \pmod{12}$. In Chapter 1 we provide background knowledge and introduce the problem. In Chapter 2 we discuss some important known results to the problem, introduce the needed ingredients, and explain the methodology of the construction. Finally, in Chapter 3, we conclude with a summary and discuss possibilities for future work.

Chapter 1

Background and Introduction

1.1 Background

The study of combinatorial designs has been motivated by many applications over time, including but not limited to experimental design, statistical applications, cryptography, and software engineering. In this report, we focus our scope of study to a particular type of design, the Steiner triple system. We will define a Steiner triple system in a moment, but first let us introduce the notation and terminology for a t -design. A t - (v, k, λ) design is a pair (V, \mathcal{B}) where V is a v -element set of *points* and \mathcal{B} is composed of k -element subsets of X called *blocks*, wherein every t -element subset is found in exactly λ blocks. A *Steiner triple system* is a 2 - $(v, 3, 1)$ design.

There are $b = \frac{v(v-1)}{6}$ blocks and each point of V appears in $r = \frac{v-1}{2}$ blocks. We will denote such a triple system as STS(v). A Steiner triple system of order 7 is given in Figure 1.1.

$$\{1, 4, 3\}, \{3, 5, 7\}, \{1, 5, 2\}, \{1, 6, 7\}, \{2, 3, 6\}, \{2, 4, 7\}, \{4, 5, 6\}$$

Figure 1.1: The 7 blocks of an STS(7)

Reverend T.P. Kirkman proved the necessary and sufficient conditions for the existence of a Steiner triple system in 1847 [11].

Theorem 1.1. [11] *A Steiner triple system of order v exists if and only if $v \equiv 1, 3 \pmod{6}$.*

The purpose of this report is to introduce a new method for decomposing the blocks of a certain type of Steiner triple system into *partial parallel classes* (PPCs) of a given size. We therefore now define a partial parallel class. A *parallel class* of an STS(v) is a set of disjoint blocks that partition the point-set, V . Steiner triple systems that are partitionable into parallel classes are called *Kirkman triple systems*, denoted KTS(v). As each point appears in r blocks, there are r parallel classes, each of size $\frac{v}{3}$. An example can be found in Figure 1.2.

Ray-Chaudhuri and Wilson proved in 1971 the necessary and sufficient conditions for the existence of a KTS(v).

1	2	3	1	4	7	1	5	9	1	6	8
4	5	6	2	5	8	2	6	7	2	4	9
7	8	9	3	6	9	3	4	8	3	5	7

Figure 1.2: The 4 parallel classes and 12 blocks of a KTS(9)

Theorem 1.2. [13] *A Kirkman triple system of order v exists if and only if $v \equiv 3 \pmod{6}$.*

Our method requires a few more types of combinatorial designs. We give the definitions for these now, but we will use them in subsequent chapters. We introduce a design called a *group divisible design*, denoted GDD. A GDD is a triple $(V, \mathcal{G}, \mathcal{B})$, where V is a point-set of order v and the following properties hold:

- \mathcal{G} partitions V into nonempty subsets called *groups*.
- A group, $G \in \mathcal{G}$ and a block, $B \in \mathcal{B}$, share at most one point.
- Every pair of points from distinct groups is found in precisely one block.

A k -GDD is a GDD whose blocks are of size k and has the property that each pair of distinct elements appear in precisely one block. We concern ourselves with the case in which $k = 3$, denoted 3-GDD, and the groups are of uniform size. To denote a 3-GDD where there are u groups of size g we write 3-GDD(g^u). A *resolvable group divisible design* is a GDD whose blocks can be partitioned into parallel classes.

Similarly, we denote an RGDD with blocks of size 3 and has u groups of size g as a 3 -RGDD(g^u). We give an example of a 3 -RGDD of type 4^3 in Figure 1.3. Bose, Parker, and Shrikhande proved the existence of these designs in all but a few cases.

Theorem 1.3. [3],[2] *A resolvable group divisible design of order g^3 with blocks of size 3 exists if and only if $g \neq 2, 6$.*

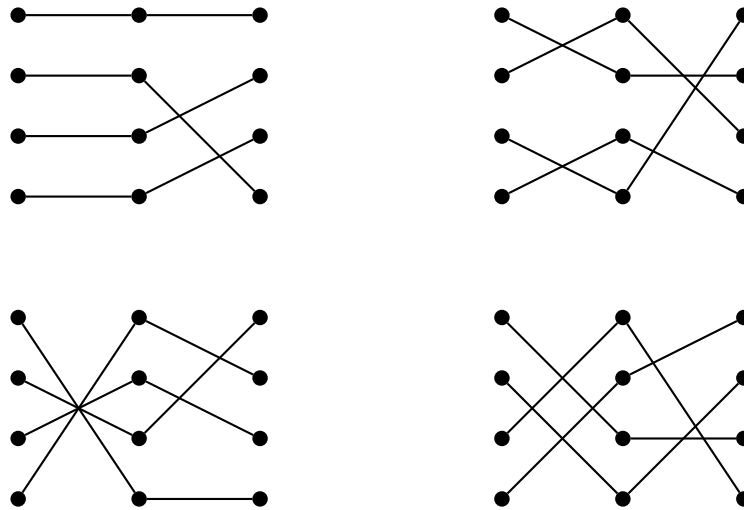

Figure 1.3: A 3 -RGDD of type 4^3

We will also require the use of Kirkman frames. You can intuitively consider a Kirkman frame as a Kirkman triple system with “holes,” but we include a formal definition below. A *Kirkman frame* of order v is a set of partial parallel classes, \mathcal{P} of the point-set V , such that:

- Each $P \in \mathcal{P}$ is a partition of $V \setminus G$, where $G \in \mathcal{G}$ and \mathcal{G} partitions the point-set into groups.

- The unordered pairs in the blocks of \mathcal{P} come from different holes of \mathcal{G} , where each pair occurs exactly once.

In 1985 Stinson gave us a proof of existence for uniform frames, where $g = |G|$ and u is the number of groups. [15]

Theorem 1.4. [15] *There exists a Kirkman frame of type g^u if and only if g is even, $u \geq 4$, and $g(u - 1) \equiv 0 \pmod{3}$.*

We will denote a Kirkman frame of this type as a $\text{KF}(g^u)$.

It is important for us to know some of the finer details of a Kirkman frame, such as how many parallel classes there are and how many times each group is missed. Stinson also proved this for us.

Theorem 1.5. [15] *If \mathcal{P} is a \mathcal{G} -frame then for any $G \in \mathcal{G}$ there are $\frac{1}{2}|G|$ partial parallel classes in \mathcal{P} which partition $V \setminus G$.*

In the construction that will be discussed in Chapter 2, we need Kirkman frames of type 2^4 and 4^4 . In Figures 1.4 and 1.5 you will find such frames, respectively. Notice that in the $\text{KF}(2^4)$ each group is missed once and in the $\text{KF}(4^4)$ each group is missed twice.

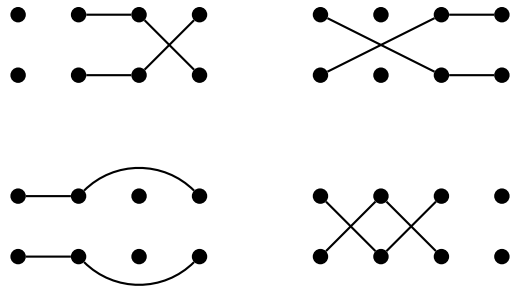

Figure 1.4: A Kirkman frame of type 2^4

1.2 Introduction

Now that we have the set the stage with the basic designs that are needed to produce many of the known results, we may talk about the work that has already been done on the problem. Colbourn, Horsley and Wang [6] were interested in determining all possible color types of triple systems. Before we introduce the notion of color types, we must talk about partial Steiner triple systems. A *partial Steiner triple system* is a pair (V, \mathcal{B}) where V is a v -element set and \mathcal{B} is a set of triples on V such that $|B \cap B'| \leq 1$ for $B \in \mathcal{B}$, $B' \in \mathcal{B}$, and $B \neq B'$. The number of triples in a $PSTS(v)$ cannot exceed $\mu(v) = \lfloor \frac{v}{3} \lfloor \frac{v-1}{2} \rfloor \rfloor - \epsilon$, where $\epsilon = 1$ if $v \equiv 5 \pmod{6}$ and $\epsilon = 0$ otherwise. Indeed, a *block coloring* of a $PSTS(v)$ in c colors is a mapping $\chi : \mathcal{B} \mapsto \{1, \dots, c\}$ so that every *color class* $\chi^{-1}(i)$, $i \in \{1, \dots, c\}$, is a partial parallel class. The *color type* of a block coloring of a $PSTS(v)$ in c colors is the sequence (m_1, m_2, \dots, m_c) such that m_i is the size of the color class for all $i = 1, \dots, c$. We use exponential notation throughout the paper; color type $w_1^{u_1}, w_2^{u_2}, \dots, w_s^{u_s}$ tells us that u_i of the

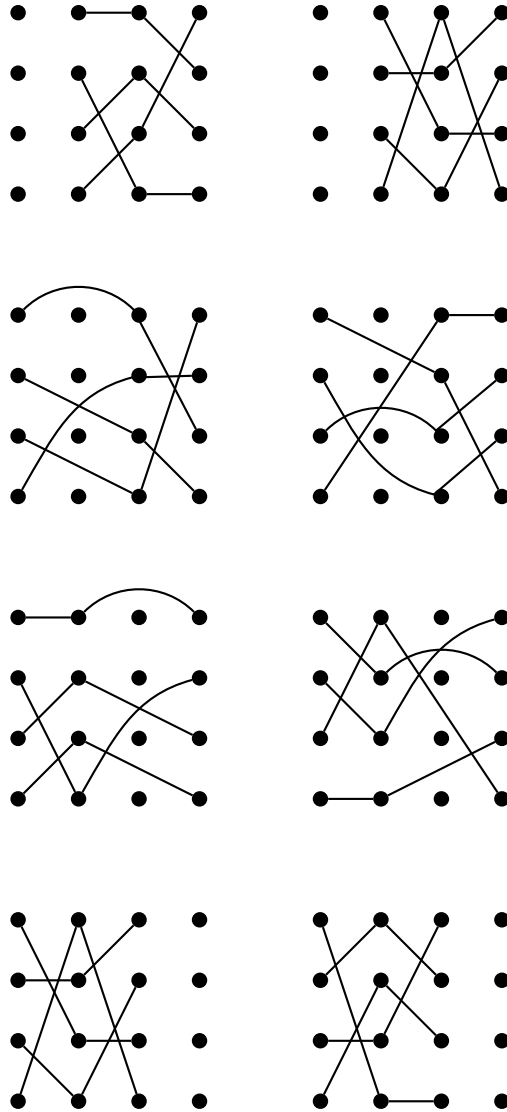

Figure 1.5: A Kirkman frame of type 4^4

parallel classes are of size w_i for $i = 1, \dots, s$. Thus, we have the basis of our problem.

Colbourn et al. conjectured the following:

Conjecture 1.1. [6] *Let $v \geq 14$. Let (m_1, \dots, m_c) satisfy $\sum_{i=1}^c m_i \leq \mu(v)$ and $m_i \leq \lfloor \frac{v}{3} \rfloor$ for $1 \leq i \leq c$. Then there exists a PSTS(v) that admits a block coloring of color type (m_1, \dots, m_c) .*

There seem to be many potential applications to solving this problem. The decomposition of the blocks of Steiner triple systems into partial parallel classes of a uniform size could possibly be used for tournament scheduling in which three opponents play at once or if each pair in each triple plays each other in one round. Then the partial parallel classes represent rounds of play in the tournament. Another possible application could be experiments where the study is conducted in rounds, or partial parallel classes, and each pair of conditions needs to be tested together. It also seems likely that there would be implications in error-correcting codes and possibly other areas of computing as well. In Chapter 2 we will discuss what results are known about this conjecture as well as discuss some important methods.

Chapter 2

Known Results and Methods

In this chapter we discuss the methods used for smaller cases and previous results. Colbourn et al. [6] proved their conjecture for $v \leq 32$, which not only gives a solution for many different Steiner triple systems, but also provides us with a few “base” colorings that we use to find some of our own colorings that are needed for $v > 32$.

2.1 Known Results

The next few results, while obvious, still provide solutions to some of the general cases for finding PPCs of uniform size. We denote a Steiner triple system of order v that can be partitioned into partial parallel classes of size m by $\text{STS}_m(v)$.

Theorem 2.1. [6] *If $v \equiv 3 \pmod{6}$, then there exists an $STS_{\frac{v}{3}}(v)$.*

Theorem 2.2. [6] *If $v = 6t + 1$ and $v \notin \{7, 13\}$, then there exists an $STS_t(v)$.*

It is obvious that $v - 1 \leq m \leq \lfloor \frac{4v-3}{3} \rfloor$ and that while $v - 1$ may not reach the bound, it is a relatively large number when considering the possible sizes of partial parallel classes for a given $STS(v)$. We are motivated by this particular case because of the following result.

Theorem 2.3. [6] *Suppose $m_1|m$ and there exists an $STS(v)$ that can be partitioned into partial parallel classes of size m . Then there exists an $STS(v)$ that can be partitioned into partial parallel classes of size m_1 .*

Thus, by finding a solution for $m = v - 1$ we also find a solution for all of the divisors of $v - 1$. A partial Steiner triple system whose triples can be partitioned into s partial parallel classes of size m is called a *signal set*, denoted $SS(v, s, m)$. That is to say, an $SS(v, s, m)$ is a $PSTS(v)$ that admits a color type m^s . An $SS(v, s, m)$ where $s = \lfloor \frac{\mu(v)}{m} \rfloor$ is a *Kirkman signal set*, $KSS(v, m)$. Colbourn et al. [7] proved the following in 2010:

Theorem 2.4. [7] *A $KSS(v, \lfloor \frac{v}{3} \rfloor)$ exists for all positive integers, v , such that $v \notin \{6, 7, 12\}$.*

However, we have limited results when looking at $m < \lfloor \frac{v}{3} \rfloor$, as we often are. It was shown by Schönheim [14] that a $PSTS(v)$ with $\mu(v)$ triples exist for all $v \geq 0$, which

we call a *maximum partial Steiner triple system*, herein denoted $\text{MPT}(v)$. Colbourn et al. [7] have the following results on partitioning the blocks of maximum partial Steiner triple systems.

Theorem 2.5. [7] *For each sufficiently large integer v , there exists an $\text{MPT}(v)$ that admits color type (m_1, m_2, \dots, m_t) for each list of positive integers m_1, m_2, \dots, m_t with $m_1, m_2, \dots, m_t \leq \frac{1}{3}(v - (9v)^{2/3}) + O(v^{1/3})$ and $m_1 + m_2 + \dots + m(t) = \mu(v)$.*

This result will in fact cover some of the cases that our construction covers, but the theorem only begins to cover triple systems where $4v - 3 \geq 1560$ and even then partial parallel classes of $v - 1$ may not be attainable by this bound. We provide a construction that will cover a number of the cases that do not meet the conditions of this asymptotic result. First we will discuss some of the results found for partial parallel classes of size $m = 2$ and $m = 4$.

Theorem 2.6. [10] *The blocks of an $\text{STS}(v)$ can be decomposed into color type $2^{\frac{b}{2}}$ if and only if $2|b$ and $v \neq 9$.*

This result tells us that we are able to decompose an $\text{STS}(v)$ into partial parallel classes of size two. Hodaj [9] developed a method for this particular decomposition and was able to extend the idea to decompositions of $\text{STS}(v)$ s into partial parallel classes of size four. We will give some of these results now.

Theorem 2.7. [9] *If $2|b$, then there exists an $\text{STS}_2(v)$ that admits color type $2^{\frac{b}{2}}$.*

Proof. This result follows immediately from Theorem 2.6. For the construction, please refer to Hodaĵ [9]. □

Theorem 2.8. [9] *If $4|b$, then there exists an $STS_4(v)$ that admits color type $4^{\frac{b}{4}}$.*

Now that we have discussed what is already known about the problem we may continue our discussion to other needed ingredients we use to construct our decomposition of an $STS(4v - 3)$ into partial parallel classes of size $v - 1$.

2.2 MOLs and RGDDs

Before we dive into the methodology that is used to partition the blocks of a Steiner triple system into partial parallel classes, we need to introduce a few more concepts needed for our decomposition. A *Latin square* is an $n \times n$ array such that each symbol from a set of n symbols occurs precisely once in each row and column. Two

0	1	2	3
1	0	3	2
2	3	0	1
3	2	1	0

Figure 2.1: A Latin square of order 4

Latin squares L and L' , both of order n , are *orthogonal* if $L(a, b) = L(c, d)$ and $L'(a, b) = L'(c, d)$ implies $a = c$ and $b = d$. Latin squares, L_1, \dots, L_m , are *mutually*

orthogonal, denoted MOLS, if for every $1 \leq i < j \leq m$, L_i and L_j are orthogonal.

In Figure 2.2 you will find an example of two mutually orthogonal Latin squares of order 3. Related to MOLS and important for our construction are orthogonal arrays.

$$L_1 = \begin{array}{|c|c|c|} \hline 1 & 2 & 3 \\ \hline 3 & 1 & 2 \\ \hline 2 & 3 & 1 \\ \hline \end{array} \quad L_2 = \begin{array}{|c|c|c|} \hline 1 & 2 & 3 \\ \hline 2 & 3 & 1 \\ \hline 3 & 1 & 2 \\ \hline \end{array}$$

Figure 2.2: 2 MOLS(3)

An *orthogonal array* of order n and size k is a k by n^2 array A , with entries from an n -element set S , such that every ordered pair is in any pair of distinct rows.

We denote such an array by $OA(k, n)$. The following example is an orthogonal array that has been constructed using the two MOLS(3) found in Figure 2.2. The first column tells us where we are getting the information to place in our orthogonal array.

Equivalent to MOLS are a type of design, which we will need, called transversal

Row	1	1	1	2	2	2	3	3	3
Column	1	2	3	1	2	3	1	2	3
L_1	1	2	3	3	1	2	2	3	1
L_2	1	2	3	2	3	1	3	1	2

Figure 2.3: An $OA(4, 3)$

designs. A *transversal design*, herein denoted $TD(k, n)$, with k groups of size n is a triple $(X, \mathcal{B}, \mathcal{G})$ such that the following are true:

- X is a set of kn points.

- \mathcal{B} is collection of k -element subsets called *blocks*.
- \mathcal{G} is a partition of X into k subsets of size n called *groups*.
- Any group and any block share exactly one point.
- Every pair of points from distinct groups is found in only one block.

In the following figure you will find an example of a transversal design, which was constructed from our $OA(4, 3)$.

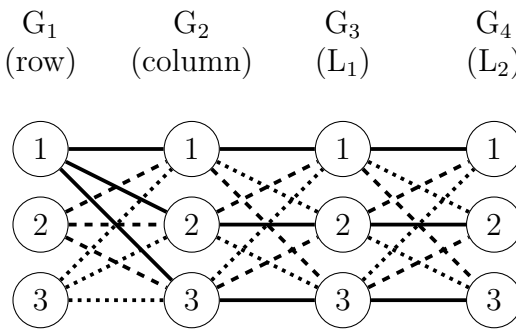

Figure 2.4: A $TD(4, 3)$

We say the blocks are *transverse* to the groups because they contain exactly one point from each group. In fact, a transversal design is also a k -GDD of order n^k , which we have seen before. Now we relate all of these structures to one another.

Theorem 2.9. [3] *The following structures are all equivalent:*

- $k - 2$ $MOLS(n)$
- $OA(k, n)$

- $TD(k, n)$

A *resolvable transversal design* with k groups of size n is a $TD(k, n)$ whose blocks can be partitioned into parallel classes. We will denote a resolvable $TD(k, n)$ by $RTD(k, n)$. The following result is well known.

Theorem 2.10. [3] *If there exists a $TD(k, n)$, then there exists an $RTD(k - 1, n)$.*

Considering our example for the $TD(4, 3)$, we can find the three parallel classes of the $RTD(3, 3)$, equivalently a 3 -RGDD(3^3), by taking as each parallel class the blocks that intersect G_1 in point 1, G_1 in point 2, and G_1 in point 3, but not including the points of G_1 . As we are only interested in 3 -RGDDs, we can consider $RTD(3, n)$ s. What we ultimately want is to be able to take one block from each of the parallel classes determined by the $RTD(3, n)$ to form a new parallel class. The following three results tell us when this happens.

Theorem 2.11. [12] *If there exists an $OA(k + 1, n)$, then there is an $OA(k, n)$ with n constant columns.*

Corollary 2.1. *If 3 $MOLS(n)$ exist, then there exists an $OA(5, n)$ and thus an $OA(4, n)$ with n constant columns.*

Proof. This result arises directly from Theorem 2.9 and Corollary 2.1. □

Lemma 2.1. *If there exists an $OA(4, n)$ with n constant columns, then there is a 3 -RGDD(n^3) with parallel classes P_1, P_2, \dots, P_n with the property that there is a set of blocks $B_1 \in P_1, B_2 \in P_2, \dots, B_n \in P_n$ such that $\{B_1, B_2, \dots, B_n\}$ partition the point-set.*

Proof. Suppose an $OA(4, n)$ with n constant columns exists. Then by Theorem 2.9 a 3 -RGDD(n^3) exists. We denote the parallel classes P_i , where $P_i = \{B_j | B_j \text{ intersects } G_1 \text{ in point } i\}$. Then because the $OA(4, n)$ has n constant columns, there exists a $B_1 \in P_1, B_2 \in P_2, \dots, B_n \in P_n$ such that $\{B_1, B_2, \dots, B_n\}$ partition the point-set. □

We require 3 MOLS($\frac{v-1}{4}$) or 3 MOLS($\frac{v-1}{2}$) in the case when $v \equiv 9 \pmod{12}$ and the case when $v \equiv 3 \pmod{12}$, respectively. Thankfully Colbourn and Dinitz [5] managed to develop a package in Maple that tells us what is known about the existence for MOLS of order v .

Lemma 2.2. [5] *It is known that 3 MOLS(v) exist for all v , $v \notin \{2, 3, 6, 10\}$.*

We conclude our discussion on TDs, MOLS, and OAs with the following theorem:

Theorem 2.12. *If $n \notin \{2, 3, 6, 10\}$, then there exists a 3 -RGDD(n^3) with parallel classes P_1, P_2, \dots, P_n with the property that there is a set of blocks $B_1 \in P_1, B_2 \in P_2, \dots, B_n \in P_n$ such that $\{B_1, B_2, \dots, B_n\}$ partition the point-set.*

Proof. If $n \notin \{2, 3, 6, 10\}$, by Lemma 2.2 there exists at least 3 MOLS(n). Thus by Corollary 2.1, there exists an OA($4, n$) with n constant columns. Finally, by Lemma 2.1, there exists a 3-RGDD(n^3) with the desired property. \square

2.3 KT Designs

The work that Colbourn et al. [6] have done not only provides some solutions to the problem, as previously mentioned, but also provides some additional ingredients that are needed for our construction. In this section we discuss and expand upon their construction.

Theorem 2.13. [6] *Suppose a color type T' can be obtained by applying the following iterations:*

- *Take an entry y in the sequence and replace it with an entry a such that $a \leq y$.*
- *Take an entry y in the sequence and replace it with two entries a and b such that $a + b = y$.*
- *Take two entries y and z such that $y \leq z \leq 2y$ and replace them with three entries, a, b , and c such that $a + b + c = y + z$, $a \leq y$, $b \leq z$, $(a, b, c) \neq (2, 2, 2)$ and either $2y < 2a + b$ or $a = b = c = 2y/3 = 2z/3$.*

Then if (V, \mathcal{B}) is a PSTS that admits color type T , there is a PSTS (V, \mathcal{B}') with $\mathcal{B}' \subseteq \mathcal{B}$ that admits color type T' .

You can think of color types as partial parallel classes of given sizes, not necessarily uniform. This is an important result because it tells us that if there is a certain base coloring of a triple system, then we can obtain a different coloring by breaking up the base coloring into different pieces by following the method described in Theorem 2.13. We use this theorem to break down our base coloring into smaller pieces to construct what we are referring to as KT designs.

A Steiner triple system of order v that admits a block coloring of color type $c_1^{m_1} c_2^{m_2} \dots c_n^{m_n}$ is called a $\text{KT}(v; c_1^{m_1} c_2^{m_2} \dots c_n^{m_n})$ if it has the property that there is a point that appears in each of the m_1 partial parallel classes of size c_1 . An example of a $\text{KT}(15; 2^7 3^3 4^3)$ is given in Figure 2.5, where the colored blocks represent the decomposition of the blocks into color type 2^7 . Notice that each partial parallel class of size 2 contains the point ∞ and that the remainder of the blocks in each parallel class form a decomposition of the blocks into color types 3^3 and 4^3 . Similarly, an example of a $\text{KT}(21; 4^{10} 5^6)$ is given in Figure 2.6, where the colored blocks represent the decomposition of the blocks into color type 4^{10} . Notice that each partial parallel class of size 4 contains the point ∞ and that the remainder of the blocks in each parallel class form a decomposition of the blocks into color type 5^6 .

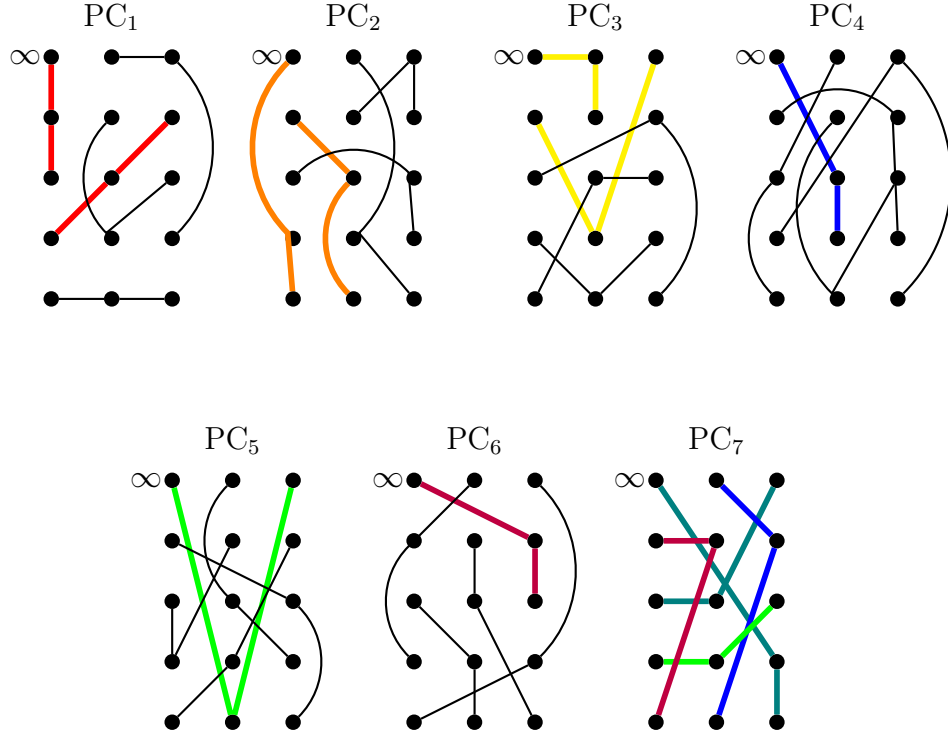

Figure 2.5: A $KT(15; 2^7 3^3 4^3)$

As Colbourn et al. [6] only have results for base color types for triple systems of order v , where $v \leq 32$, we have found a recursive construction that helps us find KT's.

2.4 Main Lemmas

In this section we develop the constructions for an $STS(4v - 3)$ whose blocks can be partitioned into partial parallel classes of size $v - 1$. We begin by giving some recursive constructions for $KT(v)$ s, a necessary ingredient for our decomposition.

Lemma 2.3. *Suppose $v \equiv 9 \pmod{12}$. If there exists a $KT(v; 4^{\frac{v-1}{2}} (\frac{v-1}{4})^{\frac{2v}{3}-8})$, then*

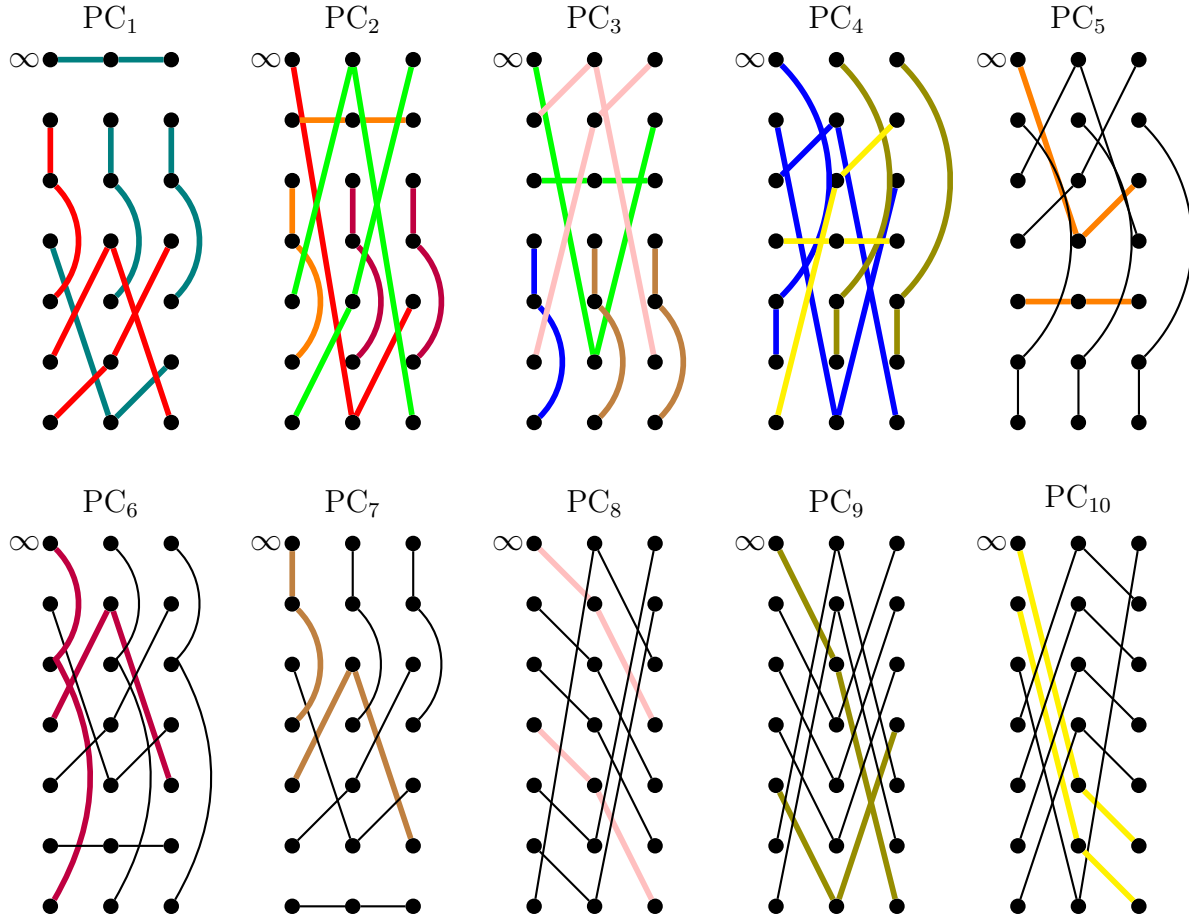

Figure 2.6: A $KT(21; 4^{10}5^6)$

there exists a $KT(4v - 3; 4^{2(v-1)}(v - 1)^{\frac{8v-30}{3}})$.

Proof. We begin by taking four copies of our $KT(v; 4^{\frac{v-1}{2}}(\frac{v-1}{4})^{\frac{2v}{3}-8})$, say $KT_1, KT_2, KT_3,$ and KT_4 on $G_1, G_2, G_3,$ and G_4 respectively, such that they intersect in exactly one point, say ∞ . We therefore have $4(v - 1) + 1 = 4v - 3$ points. Then on each copy we have a $KT(v; 4^{\frac{v-1}{2}}(\frac{v-1}{4})^{\frac{2v}{3}-8})$. This covers all of the pairs within each group, but it does not cover the transverse pairs, so we do not yet have an $STS(v)$. A $KF((v - 1)^4)$

exists [15] because as $v \equiv 9 \pmod{12}$, then $v-1$ is even and $3(v-1) \equiv 0 \pmod{3}$. Then on $G_1 \setminus \{\infty\}, G_2 \setminus \{\infty\}, G_3 \setminus \{\infty\}$, and $G_4 \setminus \{\infty\}$, place a $\text{KF}((v-1)^4)$. As we have covered all of the transverse pairs in addition to all of the pairs within each group, we have an $\text{STS}(4v-3)$. We also have a KT because ∞ appears exactly once in all of partial parallel classes of size 4. Now we need to show that we can obtain a KT with the desired color type. Each partial parallel class of size 4 is disjoint, excepting ∞ , as we wanted. There are $4 \cdot \frac{v-1}{2} = 2(v-1)$ of them, which gives us the desired number. The blocks from the partial parallel classes of size $\frac{v-1}{4}$ in KT_i and KT_j are vertex disjoint. To construct partial parallel classes of size $v-1$, let $P_{i,j}$ be the i -th parallel class of size $\frac{v-1}{4}$ in KT_j , $i = 1, 2, \dots, \frac{2v}{3} - 8$, $j = 1, 2, 3, 4$. Then for each $i = 1, 2, \dots, \frac{2v}{3} - 8$, $(P_{i,1} \cup P_{i,2} \cup P_{i,3} \cup P_{i,4})$ is a parallel class of size $v-1$. The $\text{KF}((v-1)^4)$ that was placed on $G_1 \setminus \{\infty\}, G_2 \setminus \{\infty\}, G_3 \setminus \{\infty\}$, and $G_4 \setminus \{\infty\}$ has $2(v-1)$ partial parallel classes of size $v-1$. Therefore we have $\frac{2v-24}{3} + 2(v-1) = \frac{2v-24}{3} + \frac{6v-6}{3} = \frac{8v-30}{3}$ partial parallel classes of size $v-1$. Thus a $\text{KT}(4v-3; 4^{2(v-1)}(v-1)^{\frac{8v-30}{3}})$ has been constructed. \square

Lemma 2.4. *Suppose $v \equiv 3 \pmod{12}$. If there exists a $\text{KT}(v; 2^{\frac{v-1}{2}} (\frac{v-3}{4})^{\frac{v-6}{3}} (\frac{v+1}{4})^{\frac{v-6}{3}})$, then there exists a $\text{KT}(4v-9; 2^{2v-5} (v-3)^{\frac{4v-15}{3}} (v-2)^{\frac{4v-15}{3}})$.*

Proof. We begin by taking four copies of a $\text{KT}(v; 2^{\frac{v-1}{2}} (\frac{v-3}{4})^{\frac{v-6}{3}} (\frac{v+1}{4})^{\frac{v-6}{3}})$, say $\text{KT}_1, \text{KT}_2, \text{KT}_3$, and KT_4 on G_1, G_2, G_3 , and G_4 respectively, such that they intersect in exactly one block, say $\{\infty, a, b\}$. Thus $|G_1 \cup G_2 \cup G_3 \cup G_4| = 4(v-3) + 3 = 4v-9$ and

on each copy KT_i , $i = 1, 2, 3, 4$, we have a $\text{KT}(2^{\frac{v-1}{2}} (\frac{v-3}{4})^{\frac{v-6}{3}} (\frac{v+1}{4})^{\frac{v-6}{3}})$. This covers all of the pairs within each group, but it does not cover the transverse pairs, so we do not yet have an $\text{STS}(v)$. A $\text{KF}((v-3)^4)$ exists [15] because as $v \equiv 3 \pmod{12}$, then $v-1$ is even and $3(v-1) \equiv 0 \pmod{3}$. Then on $G_1 \setminus \{\infty\}$, $G_2 \setminus \{\infty\}$, $G_3 \setminus \{\infty\}$, and $G_4 \setminus \{\infty\}$, place a $\text{KF}((v-3)^4)$. As we have covered all of the transverse pairs in addition to all of the pairs within each group, we have an $\text{STS}(4v-9)$. We do not yet have a KT , because the triple $\{\infty, a, b\}$ appears in all of the partial parallel classes of size 2. This triple can appear in at most 1 partial parallel class of size 2, so we remove it from three of the KT s, say KT_2 , KT_3 , and KT_4 , to form three partial parallel class of size 1. Now that we have a KT , we need to show that we get a KT with the desired color type. Each partial parallel class of size 2 is now disjoint from all of the others. We have $\frac{v-1}{2} + 3(\frac{v-3}{2}) = \frac{v-1}{2} + \frac{3v-9}{2} = 2v-5$ partial parallel classes of size 2. Now break the $\frac{v-6}{3}$ PPCs of size $\frac{v+1}{4}$ on each group into $\frac{v-6}{3}$ PPCs of size 1 and $\frac{v-6}{3}$ PPCs of size $\frac{v-3}{4}$. Then, as the $\text{KF}((v-3)^4)$ misses each group $\frac{v-3}{2}$ times, we pair each $\frac{v-6}{3}$ color types of 1^1 on each group with $\frac{v-6}{3}$ frame parallel classes of size $v-3$ for a total of $4(\frac{v-6}{3}) = \frac{4v-24}{3}$ PPCs of size $v-2$. This leaves $\frac{v+3}{6}$ frame parallel classes of size $v-3$ that miss each group. We still have three 1^1 colorings on G_2, G_3 , and G_4 . Pairing each of these with one frame parallel class of size $v-3$, where the appropriate group is missed, gives us a total of $\frac{4v-15}{3}$ PPCs of size $v-2$. This also leaves $\frac{v+3}{6}$ frame parallel classes of size $v-3$ that miss G_1 and $\frac{v-3}{6}$ frame parallel classes of size $v-3$ that miss G_2, G_3 , and G_4 , respectively. What remains is to count the PPCs of size

$v - 3$. We have $3\left(\frac{v-3}{6}\right) + \frac{v+3}{6}$ PPCs of size $v - 3$ from the frame parallel classes. The blocks from the partial parallel classes of size $v - 3$ in KT_i and KT_j are vertex disjoint. As we want partial parallel classes of size $v - 3$, we take the union of the blocks of partial parallel class i in $\text{KT}_1, \text{KT}_2, \text{KT}_3$, and KT_4 for $i = 1, 2, \dots, \frac{2(v-3)}{6}$. This yields $\frac{4v-15}{3}$ PPCs of size $v - 3$. Thus we have a $\text{KT}(4v - 9; 2^{2v-5}(v - 3)^{\frac{4v-15}{3}}(v - 2)^{\frac{4v-15}{3}})$, as desired. \square

Theorem 2.14. *There exists a $\text{KT}(21; 4^{10}5^6)$, a $\text{KT}(15; 2^73^34^3)$, and a $\text{KT}(27; 2^{13}6^77^7)$.*

Proof. The given KTs were found by hand and can be seen in Figure 2.6, Figure 2.5 and Figure A.1, respectively. \square

Next we turn to the problem of partitioning the b blocks of an $\text{STS}(4v - 3)$, where $v \equiv 3 \pmod{6}$ into partial parallel classes of size $v - 1$.

2.4.1 Case 1: $v \equiv 9 \pmod{12}$

Lemma 2.5. *Suppose $v \equiv 9 \pmod{12}$. If there exists a $\text{KT}(v; 4^{\frac{v-1}{2}}\left(\frac{v-1}{4}\right)^{\frac{2v}{3}-8})$, then there is an $\text{STS}(4v - 3)$ whose blocks can be partitioned into PPCs of size $v - 1$.*

Proof. We start with a 3-frame of type 4^4 , found in Figure 1.5. On each block of

the chosen 3–frame, we inflate the points to size $\frac{v-1}{4}$. Thus we let the point-set of the desired STS($4v-3$) consist of the $v-1$ vertices in each group, G_1, G_2, G_3 , and G_4 , along with the point ∞ . On each inflated block of each frame parallel class, we place a 3–RGDD($(\frac{v-1}{4})^3$). Then every transverse pair is in exactly one transverse triple. The only pairs that have not been covered are the ones that lie within a group and pairs that contain ∞ . Upon each group include the point ∞ and place upon it a KT($v; 4^{\frac{v-1}{2}}(\frac{v-1}{4})^{\frac{2v}{3}-8}$), which exists by assumption. In this way, we have now constructed a set of triples in which every pair has been covered exactly once. Thus we have an STS($4v-3$). Note that the number blocks, b , found in such an STS($4v-3$) is as follows

$$b = \frac{(4v-3)(4v-4)}{3 \cdot 2} = \frac{(4v-3)(2v-2)}{3}.$$

Because $v \equiv 9 \pmod{12}$, it follows that 3 divides $4v-3$ and hence $v-1$ also divides b . Therefore, if we can construct an STS($4v-3$) that can be resolved into partial parallel classes of size $v-1$, there will be

$$\frac{b}{v-1} = \frac{2(4v-3)}{3}$$

such parallel classes. The key ingredient to construct our partial parallel classes of the STS($4v-3$) is the existence of a KT($v; 4^{\frac{v-1}{2}}(\frac{v-1}{4})^{\frac{2v}{3}-8}$). We now begin the process of constructing our partial parallel classes of size $v-1$ from the STS($4v-3$). We will construct our partial parallel classes of size $v-1$ in three ways, which we denote as

types.

Type I:

For $j = 1, 2, 3, 4$, let FPC_j denote a frame parallel class that misses group G_j .

For $j = 5, 6, 7, 8$ let FPC_j denote a frame parallel class that misses group G_{j-4} .

For $i = 1, 2, \dots, \frac{v-1}{4}$, let PC_i denote a parallel class in the 3-RGDD $((\frac{v-1}{4})^3)$.

Then let $P_{i,j}$ be the set of blocks from PC_i on the inflated blocks of FPC_j .

Take one block from each PC_i , $i = 1, 2, \dots, \frac{v-1}{4}$ on each FPC_j , $j = 1, 2, \dots, 8$.

However, each FPC_j has four disjoint blocks, so we are removing a total of four

blocks from $P_{i,j}$. By Theorem 2.1, we may choose the $\frac{v-1}{4}$ blocks from PC_i to

be disjoint. Let $B_{i,j}$ be the four blocks removed from $P_{i,j}$. Then $\bigcup_{i=1}^{\frac{v-1}{4}} B_{i,j}$ is a

partial parallel class of size $v - 1$ for each j , $j = 1, 2, \dots, 8$. Thus we get a total

of 8 PPCs of size $v - 1$.

Type II:

For $i = 1, \dots, \frac{v-1}{4}$ and $j = 1, \dots, 8$, $P_{i,j}$ consists of a set of $v - 5$ blocks, because

four were removed. By assumption, there exists a $\text{KT}(v; 4^{\frac{v-1}{2}} (\frac{v-1}{4})^{\frac{2v}{3}-8})$, which

we placed upon G_1, G_2, G_3 and G_4 .

Thus we may take the union of the blocks in $P_{i,j}$ for $j = 1, \dots, 4$ with a partial

parallel class of size 4 from G_j and in $P_{i,j}$ for $j = 5, \dots, 8$ with a partial parallel

class of size 4 from G_{j-4} to form PPCs of size $v - 1$. Because each group is

missed twice by the $\text{KF}(4^4)$, we get a total of $8(\frac{v-1}{4})$ PPCs of size $v - 1$. We

are also guaranteed that ∞ appears exactly once in each of the partial parallel classes of this type.

Type III:

Lastly, we will cover what was left on each of the missed groups of the frame parallel class. We were able to place a $\text{KT}(v; 4^{\frac{v-1}{2}} (\frac{v-1}{4})^{\frac{2v}{3}-8})$ on each group, including ∞ . We have used all of the blocks from each group of size 4, but we have $\frac{2v}{3} - 8$ PPCs of size $\frac{v-1}{4}$ left on each group. Let $M_{i,j}$ be the i -th parallel class of size $\frac{v-1}{4}$ in KT_j , $i = 1, \dots, \frac{2v}{3} - 8$, $j = 1, \dots, 4$. Then $(M_{i,1} \cup M_{i,2} \cup M_{i,3} \cup M_{i,4})$ is a partial parallel class of size $v - 1$. Therefore we get a total of $(\frac{2v}{3} - 8)$ PPCs of size $v - 1$.

The objective was to get $\frac{2(4v-3)}{3}$ PPCs of size $v - 1$. From Type I we get 8, from Type II we get $2(v - 1)$ and from Type III we get $\frac{2v}{3} - 8$ partial parallel classes and thus we have $\frac{2(4v-3)}{3}$ PPCs of size $v - 1$, as desired. \square

We provide an example to illustrate the proof.

Example 2.1. Consider the case when we have an $\text{STS}(81) = \text{STS}(4 \cdot 21 - 3)$. Then $v = 21 \equiv 3 \pmod{6}$ and our objective is to partition the blocks into PPCs of size 20.

The needed ingredients are an inflated $\text{KF}(4^4)$, a 3-RGDD(5^3) and a $\text{KT}(21; 4^{10}5^6)$. We inflate the points in the frame to size $20/4 = 5$ and upon each inflated block of the frame we place an $\text{RGDD}(5^3)$. On each group, including ∞ , we place a $\text{KT}(21; 4^{10}5^6)$.

Thus, we have covered all of the transverse pairs and all of the pairs within each group, including ∞ , so we have an STS(81). In Figure 2.7 you will find an example of an inflated frame parallel class with a parallel class of the 3-RGDD(5^3) placed upon it.

Because $81 \equiv 3 \pmod{6}$ we actually have a Kirkman triple system and by Theorem 2.1 we know that the KTS(81) admits a coloring of type 27^{40} . However, our objective is find a coloring of type 20^{54} . We will partition the blocks of the KTS(81) into PPCs three different ways, as we did in Lemma 2.5:

Type I:

These partial parallel classes are formed by removing blocks from the RGDD.

This produces 8 PPCs of size 20.

Type II:

These partial parallel classes are formed by taking the blocks of the RGDD in addition to the replaced blocks from the KT. This produces 40 PPCs of size 20.

Type III:

The remaining partial parallel classes are formed based on what is left upon each group. Consider if we join them as found in Figure 2.8. This produces 6 PPCs of size 20.

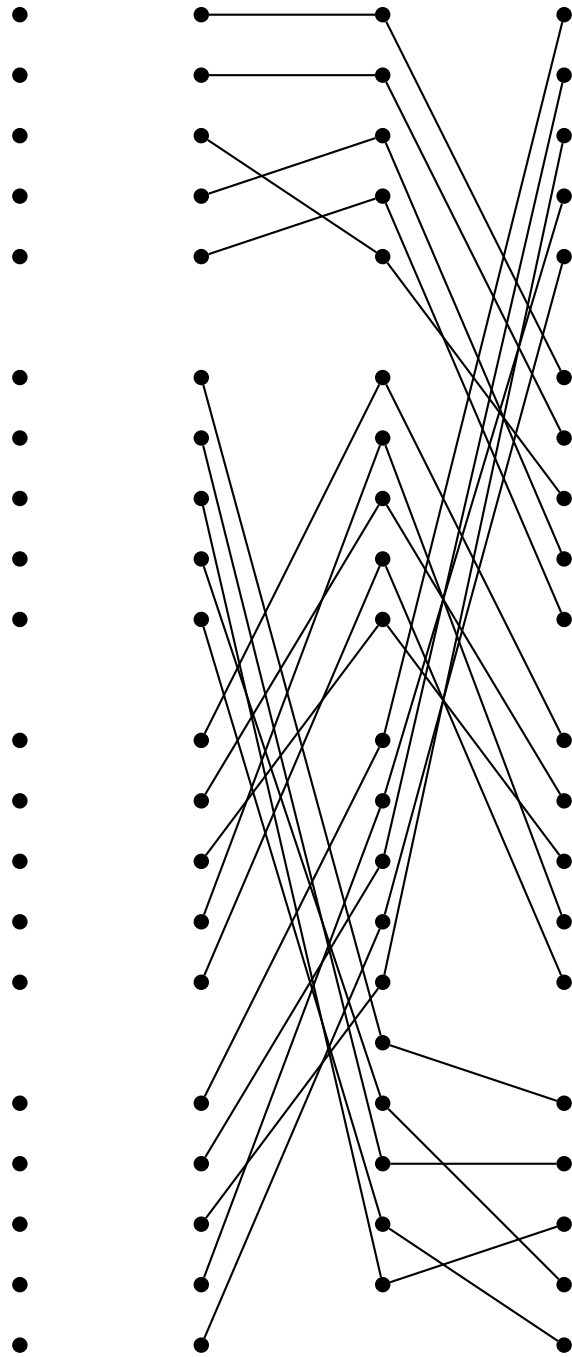

Figure 2.7: A 3-RGDD(5^3) parallel class on an inflated frame parallel class from a 3-frame of type 4^4

G_1	G_2	G_3	G_4
5	5	5	5
5	5	5	5
5	5	5	5
5	5	5	5
5	5	5	5
5	5	5	5

Figure 2.8: Type III PPCs from an STS(81)

Therefore, we have a total of 54 PPCs of size 20.

2.4.2 Case 2: $v \equiv 3 \pmod{12}$

Lemma 2.6. *Suppose $v \equiv 3 \pmod{12}$. If there exists a $KT(v; 2^{\frac{v-1}{2}} (\frac{v-3}{4})^{\frac{v-6}{3}} (\frac{v+1}{4})^{\frac{v-6}{3}})$, then there exists an $STS(4v-3)$ whose blocks can be partitioned into PPCs of size $v-1$.*

Proof. The proof for the case when $v \equiv 3 \pmod{12}$ is very similar to the previous case, with only a few noted differences. We begin with a 3-frame of type 2^4 , found in Figure 1.4. On each block of the chosen 3-frame, we inflate the points to size $\frac{v-1}{2}$. Thus we let the point-set of the desired $STS(4v-3)$ consist of the $v-1$ vertices in each group, G_1, G_2, G_3 , and G_4 , along with the point ∞ . On each inflated block of each frame parallel class, we place a 3-RGDD($(\frac{v-1}{2})^3$). Then every transverse pair is in exactly one transverse triple. The only pairs that have not been covered

are the ones that lie within a group and pairs that contain ∞ . Upon each group include the point ∞ and place upon it a $\text{KT}(v; 2^{\frac{v-1}{2}} (\frac{v-3}{4})^{\frac{v-6}{3}} (\frac{v+1}{4})^{\frac{v-6}{3}})$, which exists by assumption. In this way, we have now constructed a set of triples in which every pair has been covered exactly once. Thus we have an $\text{STS}(4v - 3)$. Note that the number blocks, b , found in such an $\text{STS}(4v - 3)$ is as follows

$$b = \frac{(4v - 3)(4v - 4)}{3 \cdot 2} = \frac{(4v - 3)(2v - 2)}{3}.$$

Because $v \equiv 3 \pmod{12}$ it follows that 3 divides $4v - 3$ and hence $v - 1$ also divides b . Therefore, if we can construct an $\text{STS}(4v - 3)$ that can be resolved into partial parallel classes of size $v - 1$ there will be

$$b = \frac{2(4v - 3)}{3} \cdot (v - 1)$$

such partial parallel classes. The key ingredient to construct our partial parallel classes is the existence of a $\text{KT}(v; 2^{\frac{v-1}{2}} (\frac{v-3}{4})^{\frac{v-6}{3}} (\frac{v+1}{4})^{\frac{v-6}{3}})$. We now begin the process of constructing our partial parallel classes of size $v - 1$ from the $\text{STS}(4v - 3)$. We will construct our partial parallel classes of size $v - 1$ in three ways, which we denote as types.

Type I:

For $j = 1, \dots, 4$, let FPC_j denote a frame parallel class that misses group G_j .

For $i = 1, \dots, \frac{v-1}{2}$ denote a parallel class in the 3-RGDD($(\frac{v-1}{2})^3$). Then let $P_{i,j}$ be the set of blocks from PC_i on the inflated blocks of FPC_j . For $j = 1, \dots, 4$ take one block from each PC_i , for $i = 1, \dots, \frac{v-1}{2}$. However, FPC_j has four disjoint blocks, so we are removing a total of four blocks from $P_{i,j}$. By Theorem 2.1, we may choose the $\frac{v-1}{2}$ blocks from PC_i to be disjoint. Let $B_{i,j}$ be the four blocks removed from $P_{i,j}$. Then $\bigcup_{i=1}^{\frac{v-1}{2}} B_{i,j}$ is a partial parallel class of size $v - 1$ for each $j, j = 1, \dots, 4$. Thus we get a total of 4 PPCs of size $v - 1$.

Type II:

For $i = 1, \dots, \frac{v-1}{2}$ and $j = 1, \dots, 4$, $P_{i,j}$ consists of a set of $v - 5$ blocks, because four were removed. By assumption, there exists a $\text{KT}(v; 2^{\frac{v-1}{2}} (\frac{v-3}{4})^{\frac{v-6}{3}} (\frac{v+1}{4})^{\frac{v-6}{3}})$. Thus we may take the union of the blocks in $P_{i,j}$ for $j = 1, \dots, 4$ with a partial parallel class of size 4 from G_j to form PPCs of size $v - 1$. Because each group is missed once by the $\text{KF}(4^4)$, we get a total of $4(\frac{v-1}{2})$ PPCs of size $v - 1$. We are also guaranteed that ∞ appears exactly once in each of the partial parallel classes of this type.

Type III:

Lastly, we will cover what was left on each of the missed groups of the frame parallel class. We were able to place a $\text{KT}(v; 2^{\frac{v-1}{2}} (\frac{v-3}{4})^{\frac{v-6}{3}} (\frac{v+1}{4})^{\frac{v-6}{3}})$ on each group, including ∞ . We have used all of the blocks from each group of size 2, but we have a partial Steiner triple system of color type $(\frac{v-3}{4})^{\frac{v-6}{3}} (\frac{v+1}{4})^{\frac{v-6}{3}}$ left on each group. Let $M_{i,j}$ be the i -th parallel class of size $\frac{v-3}{4}$ in $\text{KT}_j, i = 1, \dots, \frac{v-6}{3}$,

$j = 1, \dots, 4$. Let $N_{i,j}$ be the i -th parallel class of size $\frac{v+1}{4}$ in KT_j , $i = 1, \dots, \frac{v-6}{3}$,
 $j = 1, \dots, 4$. Because $2(\frac{v-3}{4}) + 2(\frac{v+1}{4}) = v - 1$, then $(M_{i,1} \cup M_{i,2} \cup N_{i,3} \cup N_{i,4})$
is a partial parallel class of size $v - 1$ and $(N_{i,1} \cup N_{i,2} \cup M_{i,3} \cup M_{i,4})$ is a partial
parallel class of size $v - 1$. Therefore we get a total of $2(\frac{v-6}{3})$ PPCs of size $v - 1$.

The objective was to get $\frac{2(4v-3)}{3}$ PPCs of size $v - 1$. From Type I we get 4, from Type
II we get $2(v - 1)$, and from Type III we get $2(\frac{v-6}{3})$ partial parallel classes and thus
we have $\frac{2(4v-3)}{3}$ PPCs of size $v - 1$, as desired. \square

Again, we will illustrate this construction with the use of an example.

Example 2.2. We consider the case when we have an $\text{STS}(57) = \text{STS}(4 \cdot 15 - 3)$.
Then $v = 15 \equiv 3 \pmod{6}$ and our objective is to partition the blocks into PPCs
of size 14. The needed ingredients are an inflated $\text{KF}(2^4)$, a $3\text{-RGDD}(7^3)$, and a
 $\text{KT}(15; 2^7 3^3 4^3)$. We inflate the points in the frame to size $14/2 = 7$ and upon each
inflated block of the frame we place an $\text{RGDD}(7^3)$. On each group, including ∞ , we
place a $\text{KT}(15; 2^7 3^3 4^3)$. Thus, we have covered all of the transverse pairs and all of
the pairs within each group, including ∞ , so we have an $\text{STS}(57)$. In Figure 2.9 you
will find an example of an inflated frame parallel class with a parallel class of the
 $3\text{-RGDD}(7^3)$ placed upon it. Because $57 \equiv 3 \pmod{6}$ we actually have a Kirkman
triple system and by Theorem 2.1 we know that the $\text{KTS}(57)$ admits a coloring of
type 19^{28} . However, our objective is find a coloring of type 14^{38} . We will partition
the blocks of the $\text{KTS}(57)$ into PPCs three different ways, as we did in Lemma 2.6:

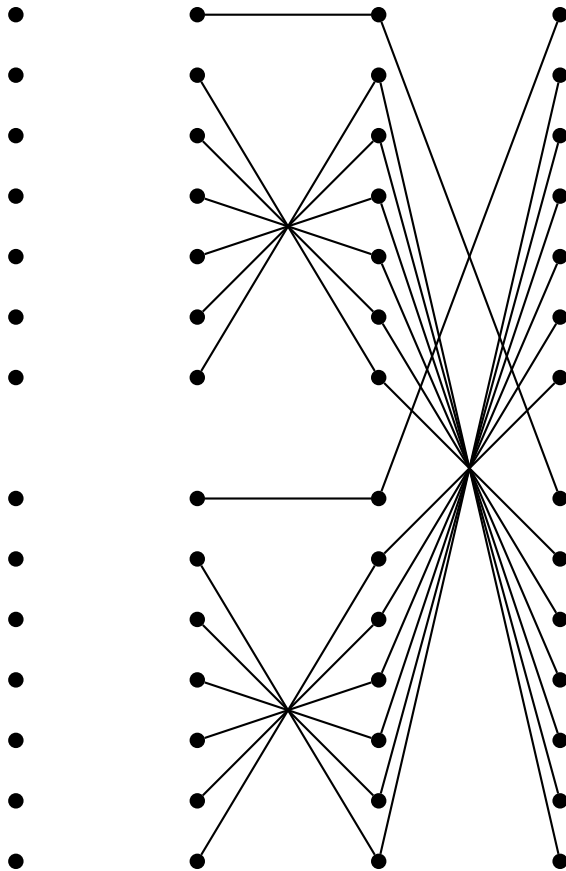

Figure 2.9: A 3-RGDD(7^3) parallel class on an inflated frame parallel class from a 3-frame of type 2^4

Type I:

These partial parallel classes are formed by removing blocks from the RGDD.

This produces 4 PPCs of size 14.

Type II:

These partial parallel classes are formed by taking the blocks of the RGDD in addition to the replaced blocks from the KT. This produces 28 PPCs of size 14.

Type III:

The remaining partial parallel classes are formed based on what is left upon each group. Consider if we join them as found in Figure 2.10. This produces 6 PPCs of size 14.

G_1	G_2	G_3	G_4
3	3	4	4
3	3	4	4
3	3	4	4
4	4	3	3
4	4	3	3
4	4	3	3

Figure 2.10: Type III PPCs from an STS(57)

Therefore, we have a total of 38 PPCs of size 14.

Chapter 3

Conclusion and Future Work

The objective of this research was to expand upon what is known on how to partition the blocks of Steiner triple systems into partial parallel classes of uniform size. We were motivated by past results and the methodology developed by Hodaj [9]. In summary, we have constructed a method for an infinite class of Steiner triple systems of order $4v - 3$ that can be decomposed into PPCs of order $v - 1$ when $v \equiv 3 \pmod{6}$. However, there are gaps within this infinite class, due to the recursive construction of the KTs.

Recall that Colbourn et al. [6] had results for $4v - 3 \leq 32$ and for $4v - 3 \geq 1560$, but partial parallel classes of size $m = v - 1$ is not necessarily attainable at the bound. So our results, partial though they may be, do cover some new cases.

Our results can be summarized as follows: We have decomposed the blocks of an $\text{STS}(4v - 3)$ into partial parallel classes of size $v - 1$ for $4v - 3 = 57, 81, 105$. However, as a result of the recursive construction of $\text{KT}(15; 2^7 3^3 4^3)$, we can find a $\text{KT}(51; 2^{25} 12^{15} 13^{15})$ and thus we can find a decomposition of the blocks of an $\text{STS}(201)$ into PPCs of size 50. Similarly, as we have a $\text{KT}(21; 4^{10} 5^6)$, we can find a $\text{KT}(81; 4^{40} 20^{46})$ and thus a decomposition of the blocks of an $\text{STS}(321)$ into PPCs of size 80. Likewise, as we have a $\text{KT}(27; 2^{13} 6^7 7^7)$, we can find a $\text{KT}(99; 2^{49} 24^{31} 25^{31})$ and thus a decomposition of the blocks of an $\text{STS}(393)$ into PPCs of size 98.

By continuing in this way, we can use the KTs to find some decompositions of STSs that do not fall within the bounds of Colbourn et al. [6].

As our results still leave parts of the problem open, it would be immensely useful to prove the following conjectures, as this will cover the gaps that we have in our $\text{STS}(4v - 3)$ s.

Conjecture 3.1. *If $v \equiv 9 \pmod{12}$, then there exists a $\text{KT}(v)$ that admits color type $4^{\frac{v-1}{2}} \left(\frac{v-1}{4}\right)^{\frac{2v}{3}-8}$.*

Conjecture 3.2. *If $v \equiv 3 \pmod{12}$, then there exists a $\text{KT}(v)$ that admits color type $2^{\frac{v-1}{2}} \left(\frac{v-3}{4}\right)^{\frac{v-6}{3}} \left(\frac{v+1}{4}\right)^{\frac{v-6}{3}}$.*

By finding these special KTs, you have the missing ingredient that is needed to put on each of the missed groups of the frame.

There are a few other avenues that could be explored to eliminate the gaps of constructions. We started with the requirement of $v \equiv 3 \pmod{6}$ so that we were able to place a Kirkman triple system on every group and therefore had blocks that were already resolved into parallel classes. However, now that we have come up with a base coloring for our $\text{KT}(v)$ s when $v \equiv 3 \pmod{12}$ that is “uneven,” so to speak, it gives hope that there may be a base coloring for $\text{KT}(v)$ s, even when $v \not\equiv 3 \pmod{6}$. It may also be possible to use similar, yet different, ingredients for new constructions. One could investigate using 3–frames with different numbers and sizes of groups, for example.

As can be seen, the problem is interesting to study and has a lot of open areas for creative solutions.

References

- [1] A. M. Assaf and A. Hartman, *Resolvable Group Divisible Designs with Block Size 3*, *Discrete Mathematics* **77** (1989), 5–20.
- [2] R. C. Bose, E. T. Parker, and S. S. Shrikhande, *Further Results on the Construction of Mutually Orthogonal Latin Squares and the Falsity of Euler's Conjecture*, *Canadian Journal of Mathematics* **12** (1960), 189–203.
- [3] R. C. Bose and S. S. Shrikhande, *On the Construction of Sets of Mutually Orthogonal Latin Squares and the Falsity of a conjecture of Euler*, *Transactions of the American Mathematical Society* **95** (1960), 191–209.
- [4] W. H. Bussey, *The tactical problem of Steiner*, *The American Mathematical Monthly* **21** (1914), 2–12.
- [5] C. J. Colbourn and J. H. Dinitz, *Making the MOLS table*, *Computational and Constructive Design Theory*, Kluwer Academic Publishers, 1996, pp. 67–134.

- [6] C. J. Colbourn, D. Horsley, and C. Wang, *Colouring Triples in Every Way: A Conjecture*, *Quaderni di Matematica* **28** (2012), 257–286.
- [7] ———, *Trails of Triples in Partial Triple Systems*, *Designs, Codes and Cryptography* **28** (2012), 257–286.
- [8] C. J. Colbourn and S. Zhao, *Maximum Kirkman Signal Sets for Synchronous Uni-Polar Multi-User Communication Systems*, *Designs, Codes and Cryptography* **20** (2000), 219–227.
- [9] J. Hodaj, *Partitioning the Blocks of a Steiner Triple System into Partial Parallel Classes*, Master’s report, Michigan Technological University, 2014.
- [10] P. Horák and A. Rosa, *Decomposing Steiner triple systems into small configurations*, *Ars Combinatoria* **26** (1988), 91–105.
- [11] T. P. Kirkman, *On a problem in Combinations*, *Cambridge and Dublin Math Journal* **2** (1847), 191–204.
- [12] E. H. Moore, *Tactical Memoranda I-III*, *American Journal of Mathematics* **18** (1896), 264–290.
- [13] D. K. Ray-Chaudhuri and R. M. Wilson, *Solution of Kirkman’s schoolgirl problem*, *Combinatorics, Proceedings of Symposia in Pure Math*, vol. 19, American Mathematical Society, 1971, pp. 187–293.

- [14] J. Schönheim, *On maximal systems of k -tuples*, *Studia Scientiarum Mathematicarum Hungarica* **1** (1996), 363–368.
- [15] D. R. Stinson, *Frames for Kirkman Triple Systems*, *Discrete Mathematics* **65** (1987), 289–300.

Appendix A

The blocks of the $\text{KT}(27; 2^{13}7^76^7)$ can be found in Figure A.1.

- 13 PPCs of size 2. Notice that the point 0_0 appears in each of these PPCs:

$$\begin{aligned} & \{\{0_0, 1_0, 2_0\}, \{0_2, 1_2, 2_2\}\}, \{\{0_0, 1_8, 2_7\}, \{0_1, 1_0, 2_8\}\}, \{\{0_0, 0_1, 0_2\}, \{1_0, 1_1, 1_2\}\}, \\ & \{\{0_0, 1_1, 2_2\}, \{0_1, 1_2, 2_3\}\}, \{\{0_0, 1_7, 2_5\}, \{0_1, 1_8, 2_6\}\}, \{\{0_0, 0_5, 0_7\}, \{0_1, 0_3, 0_8\}\}, \\ & \{\{0_0, 1_2, 2_4\}, \{0_1, 1_3, 2_5\}\}, \{\{0_0, 1_6, 2_3\}, \{0_1, 1_7, 2_4\}\}, \{\{0_0, 0_3, 0_6\}, \{0_1, 0_4, 0_7\}\}, \\ & \{\{0_0, 1_3, 2_6\}, \{0_1, 1_4, 2_7\}\}, \{\{0_0, 1_5, 2_1\}, \{0_1, 1_6, 2_2\}\}, \{\{0_0, 0_4, 0_8\}, \{0_1, 0_5, 0_6\}\}, \\ & \{\{0_0, 1_4, 2_8\}, \{0_1, 1_5, 2_0\}\} \end{aligned}$$

- 7 PPCs of size 6:

$$\begin{aligned} & \{\{0_1, 1_1, 2_1\}, \{0_4, 1_5, 2_6\}, \{1_2, 1_4, 1_6\}, \{0_2, 0_5, 0_8\}, \{0_6, 1_0, 2_3\}, \{2_0, 2_4, 2_8\}\}, \\ & \{\{0_3, 1_3, 2_3\}, \{0_4, 1_4, 2_4\}, \{0_5, 1_5, 2_5\}, \{0_6, 1_6, 2_6\}, \{0_7, 1_7, 2_7\}, \{0_8, 1_8, 2_8\}\}, \\ & \{\{0_2, 1_3, 2_4\}, \{0_3, 1_4, 2_5\}, \{0_5, 1_6, 2_7\}, \{0_6, 1_7, 2_8\}, \{0_7, 1_8, 2_0\}, \{0_8, 1_0, 2_1\}\}, \\ & \{\{0_2, 0_4, 0_6\}, \{1_0, 1_5, 1_7\}, \{1_1, 1_3, 1_8\}, \{2_0, 2_5, 2_7\}, \{2_1, 2_3, 2_8\}, \{2_2, 2_4, 2_6\}\}, \\ & \{\{1_0, 1_3, 1_6\}, \{1_1, 1_4, 1_7\}, \{1_2, 1_5, 1_8\}, \{2_0, 2_3, 2_6\}, \{2_1, 2_4, 2_7\}, \{2_2, 2_5, 2_8\}\}, \\ & \{\{0_2, 1_5, 2_8\}, \{0_3, 1_6, 2_0\}, \{0_4, 1_7, 2_1\}, \{0_5, 1_8, 2_2\}, \{0_7, 1_1, 2_4\}, \{0_8, 1_2, 2_5\}\}, \\ & \{\{0_2, 0_3, 0_7\}, \{1_0, 1_4, 1_8\}, \{1_1, 1_5, 1_6\}, \{1_2, 1_3, 1_7\}, \{2_1, 2_5, 2_6\}, \{2_2, 2_3, 2_7\}\} \end{aligned}$$

- 7 PPCs of size 7:

$$\begin{aligned} & \{\{0_2, 1_1, 2_0\}, \{0_3, 1_2, 2_1\}, \{0_4, 1_3, 2_2\}, \{0_5, 1_4, 2_3\}, \\ & \{0_6, 1_5, 2_4\}, \{0_7, 1_6, 2_5\}, \{0_8, 1_7, 2_6\}\}, \\ & \{\{0_3, 0_4, 0_5\}, \{0_6, 0_7, 0_8\}, \{1_3, 1_4, 1_5\}, \{1_6, 1_7, 1_8\}, \\ & \{2_0, 2_1, 2_2\}, \{2_3, 2_4, 2_5\}, \{2_6, 2_7, 2_8\}\}, \\ & \{\{0_2, 1_0, 2_7\}, \{0_3, 1_1, 2_8\}, \{0_4, 1_2, 2_0\}, \{0_5, 1_3, 2_1\}, \\ & \{0_6, 1_4, 2_2\}, \{0_7, 1_5, 2_3\}, \{0_8, 1_6, 2_4\}\}, \\ & \{\{0_2, 1_4, 2_6\}, \{0_3, 1_5, 2_7\}, \{0_4, 1_6, 2_8\}, \{0_5, 1_7, 2_0\}, \\ & \{0_6, 1_8, 2_1\}, \{0_7, 1_0, 2_2\}, \{0_8, 1_1, 2_3\}\}, \\ & \{\{0_2, 1_8, 2_5\}, \{0_3, 1_0, 2_6\}, \{0_4, 1_1, 2_7\}, \{0_5, 1_2, 2_8\}, \\ & \{0_6, 1_3, 2_0\}, \{0_7, 1_4, 2_1\}, \{0_8, 1_5, 2_2\}\}, \\ & \{\{0_2, 1_7, 2_3\}, \{0_3, 1_8, 2_4\}, \{0_4, 1_0, 2_5\}, \{0_5, 1_1, 2_6\}, \\ & \{0_6, 1_2, 2_7\}, \{0_7, 1_3, 2_8\}, \{0_8, 1_4, 2_0\}\}, \\ & \{\{0_2, 1_6, 2_1\}, \{0_3, 1_7, 2_2\}, \{0_4, 1_8, 2_3\}, \{0_5, 1_0, 2_4\}, \\ & \{0_6, 1_1, 2_5\}, \{0_7, 1_2, 2_6\}, \{0_8, 1_3, 2_7\}\} \end{aligned}$$

Figure A.1: A $\text{KT}(27; 2^{13}6^77^7)$