



**Michigan  
Technological  
University**

Michigan Technological University  
**Digital Commons @ Michigan Tech**

---

Michigan Tech Patents

Vice President for Research Office

---

11-25-2005

## Genetic engineering of plants through manipulation of lignin biosynthesis

Vincent Lee C. Chiang

Chung-Jui Tsai

*Michigan Technological University*, [chtsai@mtu.edu](mailto:chtsai@mtu.edu)

Wen-Jing Hu

Follow this and additional works at: <https://digitalcommons.mtu.edu/patents>

 Part of the [Biological Engineering Commons](#), and the [Molecular, Cellular, and Tissue Engineering Commons](#)

---

### Recommended Citation

Chiang, Vincent Lee C.; Tsai, Chung-Jui; and Hu, Wen-Jing, "Genetic engineering of plants through manipulation of lignin biosynthesis" (2005). *Michigan Tech Patents*. 16.  
<https://digitalcommons.mtu.edu/patents/16>

Follow this and additional works at: <https://digitalcommons.mtu.edu/patents>

 Part of the [Biological Engineering Commons](#), and the [Molecular, Cellular, and Tissue Engineering Commons](#)



US006969784B2

(12) **United States Patent**  
**Chiang et al.**

(10) **Patent No.:** **US 6,969,784 B2**  
(45) **Date of Patent:** **Nov. 29, 2005**

- (54) **GENETIC ENGINEERING OF PLANTS THROUGH MANIPULATION OF LIGNIN BIOSYNTHESIS**
- (75) Inventors: **Vincent Lee C. Chiang**, Hancock, MI (US); **Chung-Jui Tsai**, Hancock, MI (US); **Wen-Jing Hu**, Houston, TX (US)
- (73) Assignee: **Board of Control of Michigan Technological University**, Houghton, MI (US)
- (\* ) Notice: Subject to any disclaimer, the term of this patent is extended or adjusted under 35 U.S.C. 154(b) by 475 days.

- (21) Appl. No.: **10/184,385**
- (22) Filed: **Jun. 27, 2002**
- (65) **Prior Publication Data**  
US 2003/0172395 A1 Sep. 11, 2003

**Related U.S. Application Data**

- (62) Division of application No. 08/969,046, filed on Nov. 12, 1997, now Pat. No. 6,455,762.
- (51) **Int. Cl.**<sup>7</sup> ..... **C12N 15/29**; C12N 15/82; C12N 15/87; A01H 5/00
- (52) **U.S. Cl.** ..... **800/287**; 800/298; 800/290; 800/278; 536/24.1; 435/320.1; 435/419
- (58) **Field of Search** ..... 800/278, 298, 800/287, 290; 536/24.1; 435/320.1, 419

(56) **References Cited**

**U.S. PATENT DOCUMENTS**

4,940,838	A	7/1990	Schilperoort et al.
5,107,065	A	4/1992	Shewmaker et al.
5,190,931	A	3/1993	Inouye
5,451,514	A	9/1995	Boudet et al.
5,489,520	A	2/1996	Adams et al.
5,545,526	A	8/1996	Baxter Lowe
5,554,798	A	9/1996	Lundquist et al.
5,850,020	A	12/1998	Bloksberg et al.
5,952,486	A	9/1999	Bloksberg et al.
6,204,434	B1	3/2001	Bloksberg et al.
6,268,549	B1	7/2001	Sailland et al.
6,303,847	B1	10/2001	Kawaoka et al.
6,420,629	B1	7/2002	Xue et al.
6,455,762	B1	9/2002	Chiang et al.

**FOREIGN PATENT DOCUMENTS**

WO	WO 93/05160	3/1993
WO	WO 95/19697	7/1995
WO	WO 96/38567	12/1996
WO	WO 98/11205	3/1998
WO	WO 95/06128	8/1998

**OTHER PUBLICATIONS**

- GenBank Accession No. M62755, 1993.  
GenBank Accession No. X13324, 1993.  
GenBank Accession No. U12012, 1996.  
GenBank Accession No. U12013, 1996.  
GenBank Accession No. X52623, 1993.

Huang et al. In Vitro Cellular and Developmental Biology. 1991. vol. 27P: 201-207.  
Kajita et al. 1996. Plant Cell Physiol. vol.: 37: 957-965.  
Napoli et al. The Plant Cell. 1989. vol. 2: 278-289.  
Smith et al. Nature. 1988. vol. 334: 724-726.  
Tsai et al. Plant Cell Reports. 1994. vol. 14: 94-97.  
Lee et al. Plant Molecular Biology, 1995. vol. 28: 871-884.  
Ehling et al, Three 4-coumarate: coenzyme A ligases in *Arabidopsis thaliana* represent two evolutionary divergent classes in angiosperms; The Plant Journal, 19 (1) 9-20 (1991).  
Dandekar, A.M., et al., "Transformation and Foreign Gene Expression in Micropropagated Douglas-Fir (*Pseudotsuga menziesii*)", Bio/technology, 5, 587-590 (Jun. 1987).  
Douglas, C.J., et al., "Exonic Sequences Are Required for Elicitor and Light Activation of a Plant Defense Gene, but Promoter Sequences Are Sufficient for Tissue Specific Expression", The EMBO Journal, 10, 1767-1775 (1991).  
Fillatti, J.J., et al., "Agrobacterium Mediated Transformation and Regeneration of Populus", Molecular and General Genetics, 206, 192-199 (1987).  
Hu, W., et al., "Compartmentized Expression of Two Structurally and Functionally Distinct 4-Coumarate:CoA Ligase Genes in Aspen (*Populus tremuloides*)", Proc. Natl. Acad. Sci. USA, 95, 5407-5412 (Apr. 1998).  
Szerszen et al. "iaglu, a Gene from *Zea mays* Involved in Conjugation of Growth Hormone Indole-3-Acetic Acid", Science, vol. 265, pp. 1699-1701, Sep. 16, 1994.  
Doerner, et al. "Control of Root Growth and Development by Cyclin Expression", Nature, vol. 380, pp. 520-523, Apr. 11, 1996.  
McGranahan, G.H., et al., "Agrobacterium-Mediated Transformation of Walnut Somatic Embryos and Regeneration of Transgenic Plants", Bio/technology, 6, 800-804, (Jul. 1988).  
Minocha, S.C., et al., "Tissue Culture and Genetic Transformation in *Betula papyrifera* and *Populus tremuloides*", Proceedings, 1986 TAPPI Research and Development Conference, Raleigh, NC, 89-92 (Sep. 28-Oct. 1, 1986).  
Sullivan, J., et al., "Transformation of *Liquidambar styraciflua* using *Agrobacterium tumefaciens*", Plant Cell Reports, 12, 303-306 (1993).  
Uhlmann, A., et al., "Molecular Cloning and Expression of 4-Coumarate:coenzyme A Ligase, an Enzyme Involved in the Resistance Response of Soybean (*Glycine Max L.*) Against Pathogen Attack", Plant Physiology, 102, 1147-1156 (1993).  
Wilde, H.D., et al., "Expression of Foreign Genes in Transgenic Yellow-Poplar Plants", Plant Physiology, 98, 114-120 (1992).

(Continued)

*Primary Examiner*—David T. Fox  
*Assistant Examiner*—Stuart F. Baum  
(74) *Attorney, Agent, or Firm*—Michael Best & Friedrich LLP

(57) **ABSTRACT**

The invention pertains to the genetically down regulating a lignin pathway p-coumarate Co-enzyme A ligase (CCL) in trees.

## OTHER PUBLICATIONS

- Zhang, X., et al., "Molecular Cloning of 4-Coumarate:Coenzyme A Ligase in Loblolly Pine and the Roles of the Enzyme in the Biosynthesis of Lignin in Compression Wood", *Plant Physiology*, 113, 65–74 (1997).
- Holmberg, et al. "Transgenic Tobacco Expressing Vitreoscilla Hemoglobin Exhibits Enhanced Growth and Altered Metabolite Production", *Nature Biotechnology*, vol. 15, pp. 244–247, Mar. 1997.
- Adler et al., *Wood Sci Technol.*, 11, 169 (1977).
- Allina et al. 1994, *Plant Physiol.* 105 (supplement) 154.
- Altenbach, et al., *Plant Molecular Biology*, 13: 513–522 (1989).
- Arioli et al., *Science*, 279, 717 (1997).
- Atalla et al., *Science*, 227, 636 (1985).
- Atanassova et al., *The Plant Journal*, 8(4), 465–477 (1995).
- Baucher et al., *Plant Physiol.*, 112, 1479 (1996).
- Baxter-Lowe et al., Method for HLA Typing, 1996, Patent : US 5545526–A 16.
- Becker-Andre et al., Structural comparison, modes of expression, and putative cis-acting elements of the two 4-coumarate: CoA ligase genes in potato, *J. Biol. Chem.* 266, 8551–8559 (1991).
- Bjorkman, *Nature*, 174, 1057 (1954).
- Brasileiro et al., *Plant Mol. Bio* 17:441–452 (1991).
- Brasileiro et al., *Transgenic Research*, 1: 133–141 (1992).
- Braunschweiler et al., *J. Magn. Reson.*, 53, 521 (1983).
- Brunke et al., *Trends in Biotech.*, 9: 197–200 (1991).
- Buchanan-Wollaston, V., et al., "Detoxification of the Herbicide Dalapon by Transformed Plants", *J. Cell. Biochem.*, 13D, Abstract No. M503, p. 330 (1989).
- Bugos RC et al., RNA Isolation from Plant Tissue Recalcitrant to Extraction in Guanidine, *Biotechniques* 19(5):734–737, (1995).
- Busch et al., Activation of a Floral Homeotic Gene in Arabidopsis, 1999, *Science* vol. 285 pp. 585–587.
- Caldwell et al., *Physiol. Plant*, 58, 455 (1983).
- Chen, Ph.D. Thesis, North Carolina State University, Raleigh, North Carolina (1991).
- Chiang et al., *Holzforschung*, 44:147–155 (1990).
- Chiang et al., *Wood Sci. Technol.*, 17, 217 (1983).
- Ciucanu et al., *Carbohydr. Res.*, 131, 209 (1984).
- Datla et al., *Plant Sci.*, 94, 139 (1993).
- Davis, J., *Wood Chem. Technol.*, 18, 235 (1998).
- DeBlock, *Plant Physiol.* 93:1110–1116 (1990).
- Dwivedi et al., *Plant Molecular Biology* 26: 61–71 (1994).
- Elkind et al., *Proc. Natl. Acad. Sci. USA*, 87, 9057 (1990).
- Fiho et al., *Plant Cell Reports*, 13: 666–670 (1994).
- Grattapaglia et al., Loblolly pine fusiform rust disease resistance marker OPC6 primer, 1996.
- Hahlbrook et al., *Proc. Natl. Acad. Sci. USA*, 92, 4150 (1995).
- Hakomori, *J. Biochem. Tokyo*, 55, 205 (1964).
- Halpin et al., *Plant J.*, 6, 339 (1994).
- Hao, et al., Unique Mode of GCC Box Recognition by the DNA-binding Domain of Ethylene-responsive Element-binding Factor (ERF Domain) in Plant, *The Journal of Biological Chemistry*, vol. 273, No. 41, pp. 26857–26861 (1998).
- Hartley, *J. Chromatogr.*, 54, 335 (1971).
- Hibino et al., *Biosci. Biotech. Biochem.*, 59, 929 (1995).
- Higuchi (1997).
- Holsters et al., *Mol. Gen. Genet.* 163:181–187 (1978).
- Horsch R.B., Leaf Disk Transformation, *Plant Molecular Biology Manual*, A5:1–9 (1988).
- Houtman et al., *Plant Physiol.*, 107, 977 (1995).
- Howe et al., *Woody Plant Biotech.*, Plenum Press, New York, pp. 283–294 (1991).
- Hu, Wen-Jing, Isolation and Characterization of p-coumarate Co-enzyme A Ligase cDNAs and Genes from Quaking Aspen (*Populus tremuloides* Michx), Ph.D. Dissertation, Michigan Technological University, Houghton, Michigan (1997).
- Izawa et al., Plant bZIP Protein DNA Binding Specificity, *J. Mol. Biol.* 230, 1131–1144 (1993).
- Que, et al., *Plant Journal* 13 (3): 401–409 Feb. (1998).
- Jorgensen, et al., *Plant Mol Biol* Aug. 1996;31(5):957–73 (1996).
- Kajita et al., *Plant Physiol.*, 114, 871 (1997).
- Kawaoka A., Chiang VL (1995), The Molecular Cloning and Expression of Syringyl- and Guaiacyl-Specific Hydroxycinnamate:CoA Ligases from Aspen (*Populus tremuloides*), *Proceedings of the 6<sup>th</sup> International Conferences on Biotechnology in the Pulp Paper Industry*, Vienna, Austria (1995).
- Keller et al., *Transgenic Research*, 6: 385–392 (1997).
- Klopfenstein et al., *Can. J. For. Res.* 21:1321–1328 (1991).
- Lee et al., *Plant Cell*, 9, 1985 (1997).
- Leple et al., *Plant Cell Reports* 11:137–141 (1992).
- Li et al., *Plant Cell*, 13(7): 1567–1585 (2001).
- Li et al., *The Journal of Biological Chemistry*, 275(9): 6537–6545 (2000).
- Lloyd et al., *Proc. Int. Plant Prop. Soc.* 30:421–437 (1980).
- Logemann et al., *Plant J.*, 8, 865 (1995).
- Logemann et al., *Proc. Natl. Acad. Sci. USA*, 92, 5905 (1995).
- Lohmann et al., A Molecular Link between Stem Cell Regulation and Floral Patterning in Arabidopsis, *Cell*, vol. 105, 793–803 (2001).
- McGranahan et al., *Plant Cell Reports* 8:512–616 (1990).
- Ni et al., *Transgenic Research*, 3: 120–126 (1994).
- Nilsson et al., *Transgenic Res.* 1:209–220 (1992).
- Oommen et al., The Elicitor-Inducible Alfalfa Isoflavone Reductase Promoter Confers Different Patterns of Developmental Expression in Homologous and Heterologous Transgenic Plants, *The Plant Cell*, vol. 6, 1789–1803 (1994).
- Osakabe et al., *Proc. Natl. Acad. Sci. USA*, 96:8955–8960 (1999).
- Palmer et al., *J. Magn. Reson. Ser. A.*, 111, 70 (1991).
- Parsons et al. *Bio/Technology* 4:533–536 (1986).
- Pettersen et al., *J. Wood Chem & Technol.*, 11:495–501 (1991).
- Piquemal et al., *Plant J.*, 13, 17 (1998).
- Pythoud et al., *Bio/Technology* 5:1323–1327 (1987).
- Ralph et al., *JACS*, 116, 9448 (1994).
- Ranjewa et al., *Biochimie*, 58: 1255–1262 (1976).
- Rolando et al., Thioacidolysis, Methods in Lignin Chemistry, Springer-Verlag, Berlin, pp 334–349 (1992).
- Ruiz-Cabello et al., *J. Magn. Reson.*, 100, 282 (1992).
- Sambrook et al., Molecular Cloning: A Laboratory Manual, Cold Spring Harbor Laboratory Press, NY (1989).
- Schmelzer et al., *Plant Cell*, 1, 993 (1989).
- Sewalt et al., *Plant Physiol.*, 115, 41 (1997).
- Shin et al., *Biotech. Ag. & Forestry*, 29 321 (1994).
- Shirley, *Trends in Plant Sci.*, 1, 377 (1996).
- Taylor et al., *Plant J.*, 2, 959 (1992).
- Tsai et al., *Plant Physiol.*, 117, 101 (1998).

Turner et al., *Plant Cell*, 9, 689 (1997).

Van Doorselaere Et al, *The Plant Journal*, 8(6): 855–864 (1995).

Watson et al., *Recombinant DNA*, W.H. Freeman and Company, N.Y. (1992).

Whetten et al., *Annu. Rev. Plan Physiol. Plant Mol. Biol.*, 49:585–609 (1998).

Whetten et al., *Forest Ecology and Management*, 43: 301–316 (1991).

White et al., *Nature*, 205, 818 (1965).

Izawa, et al., “Plant bZIP Protein DNA Binding Specificity” *J. Mol. Biol.* (1993)230, 1131–1144.

GenBank Accession No. X05350, May 7, 1992.

GenBank Accession No. D43773, Feb. 9, 1999.

Hu et al., 1999, *Nature Biotechnology*, 17(8):808–812.

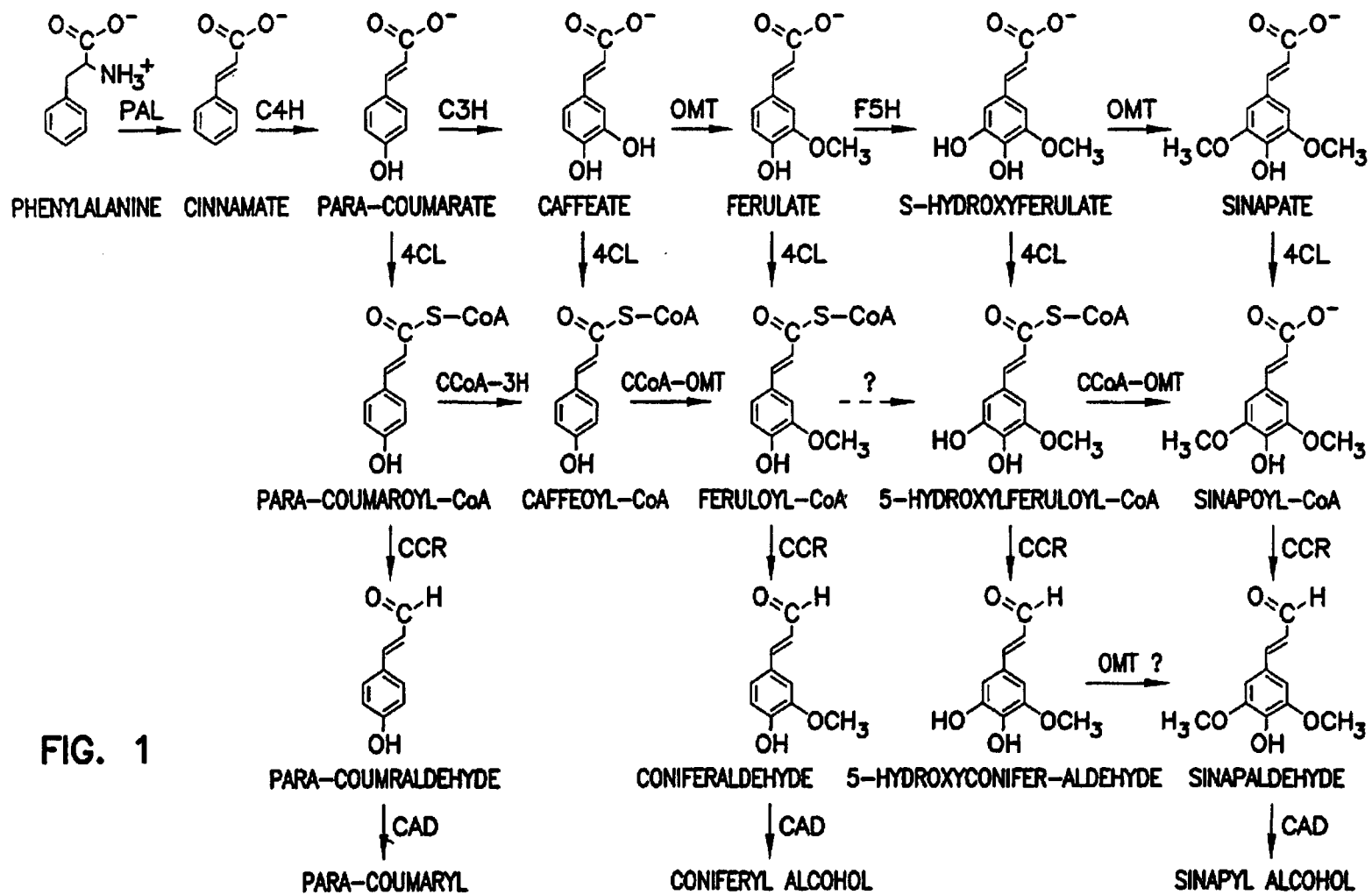

FIG. 1

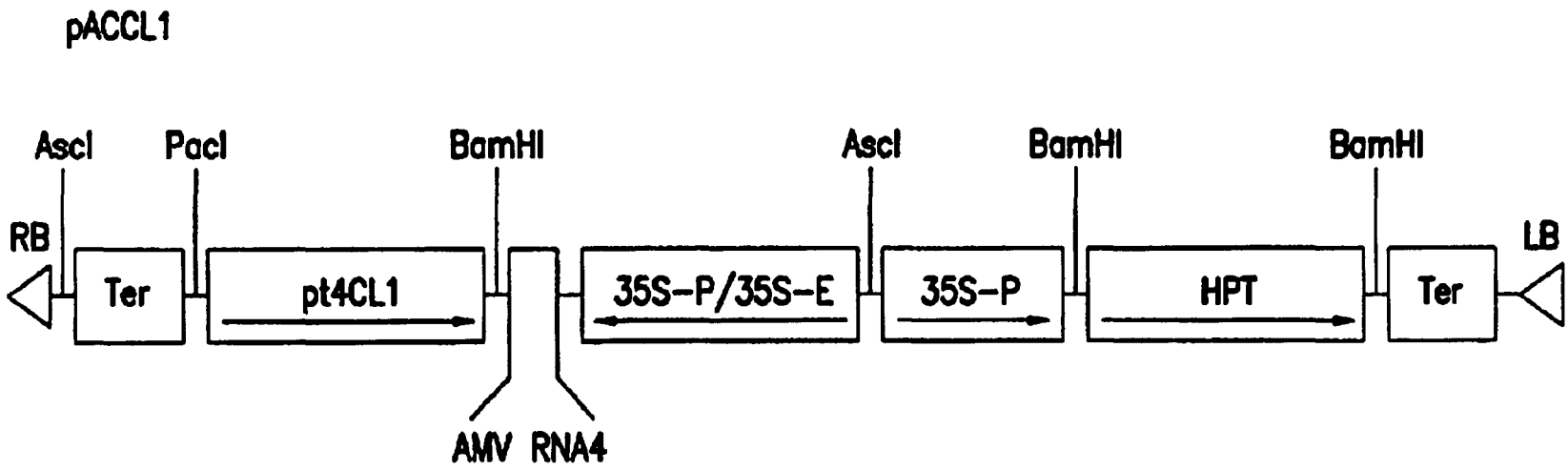

FIG. 2

Pt4CL1g-4

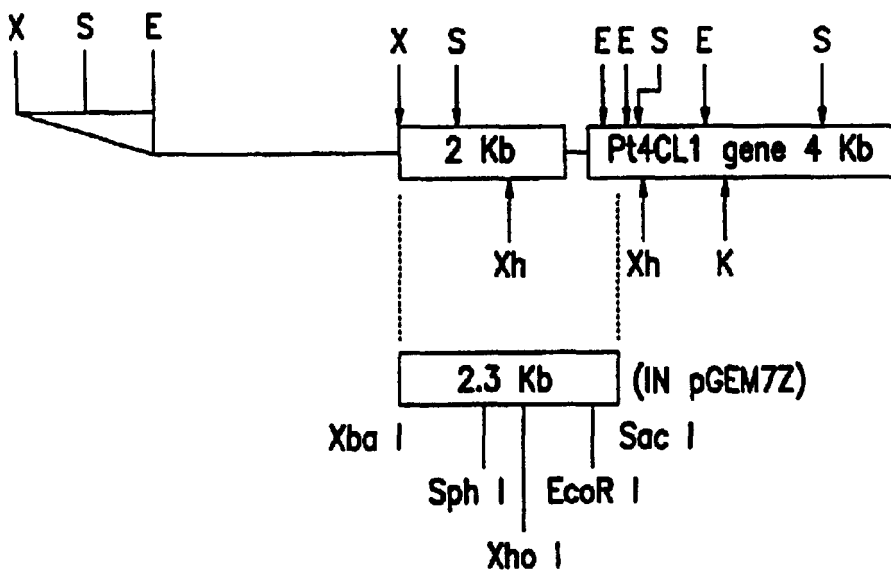
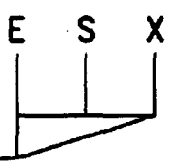

FIG. 3



— 1 Kb  
E: Eco R I  
K: Kpn I  
S: Sal I  
X: Xba I  
Xh: Xho I



PtCCL2g-11

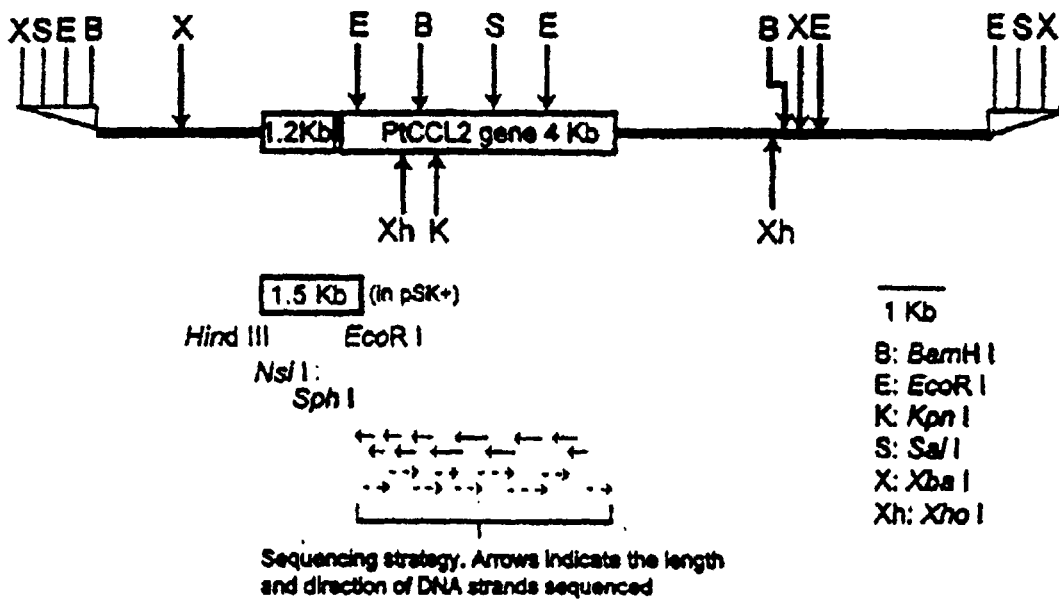

Fig. 4

p7Z-4XS

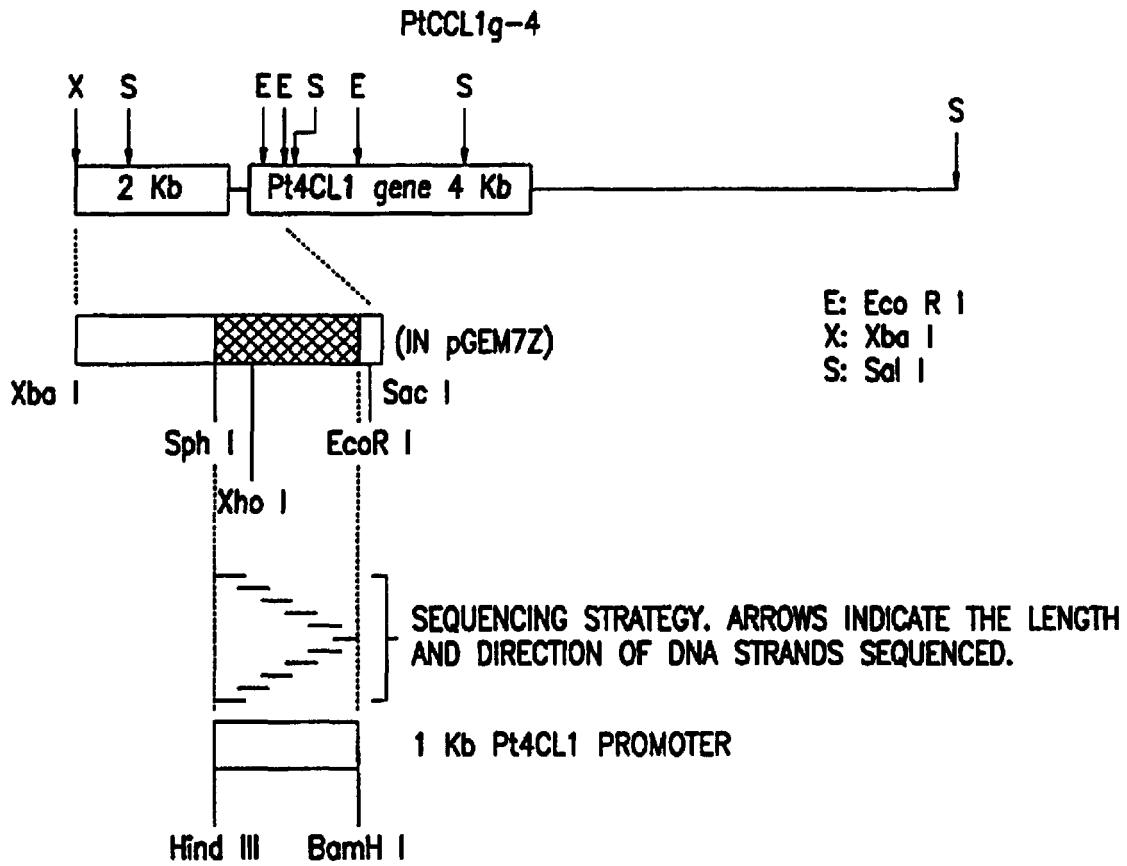

FIG. 5

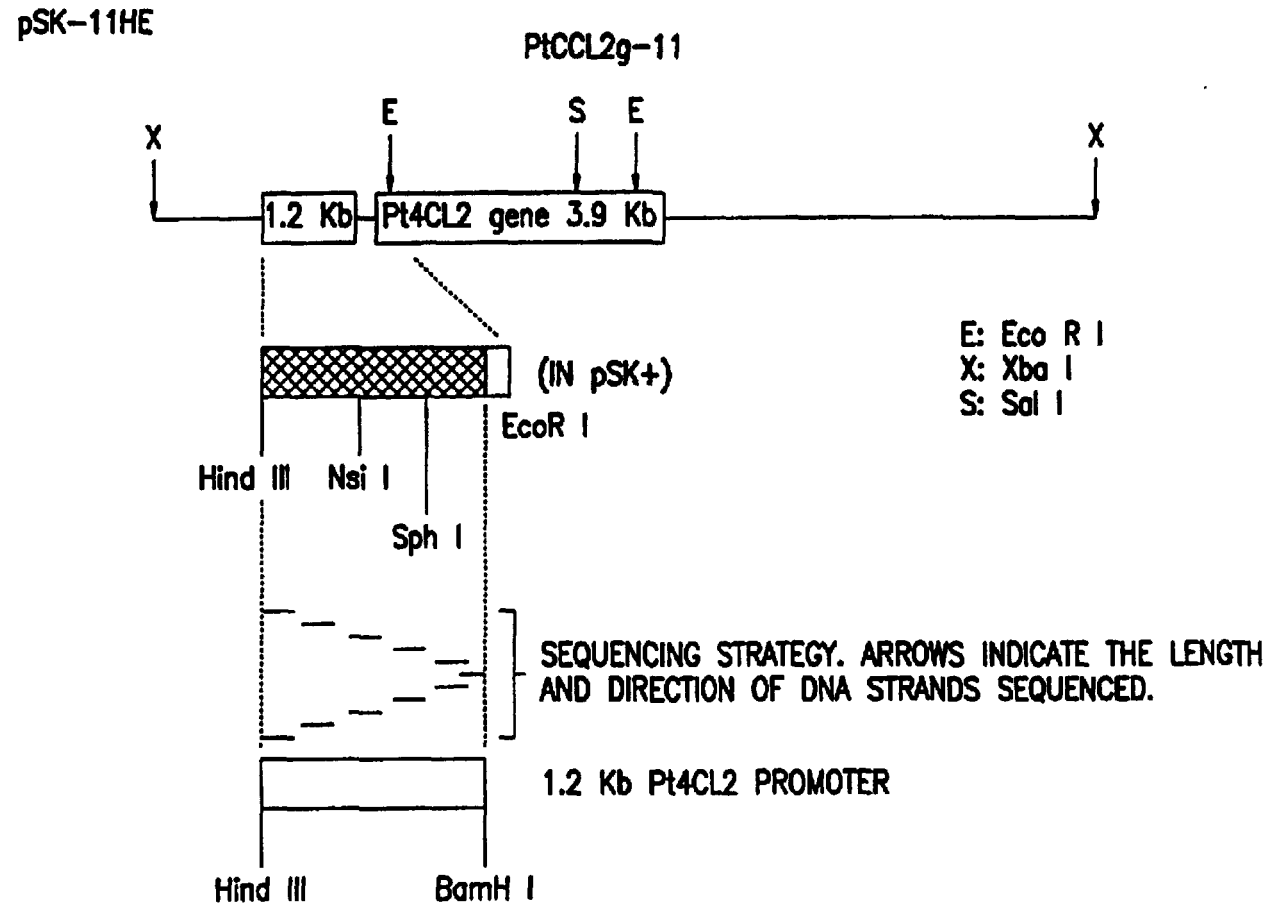

FIG. 6

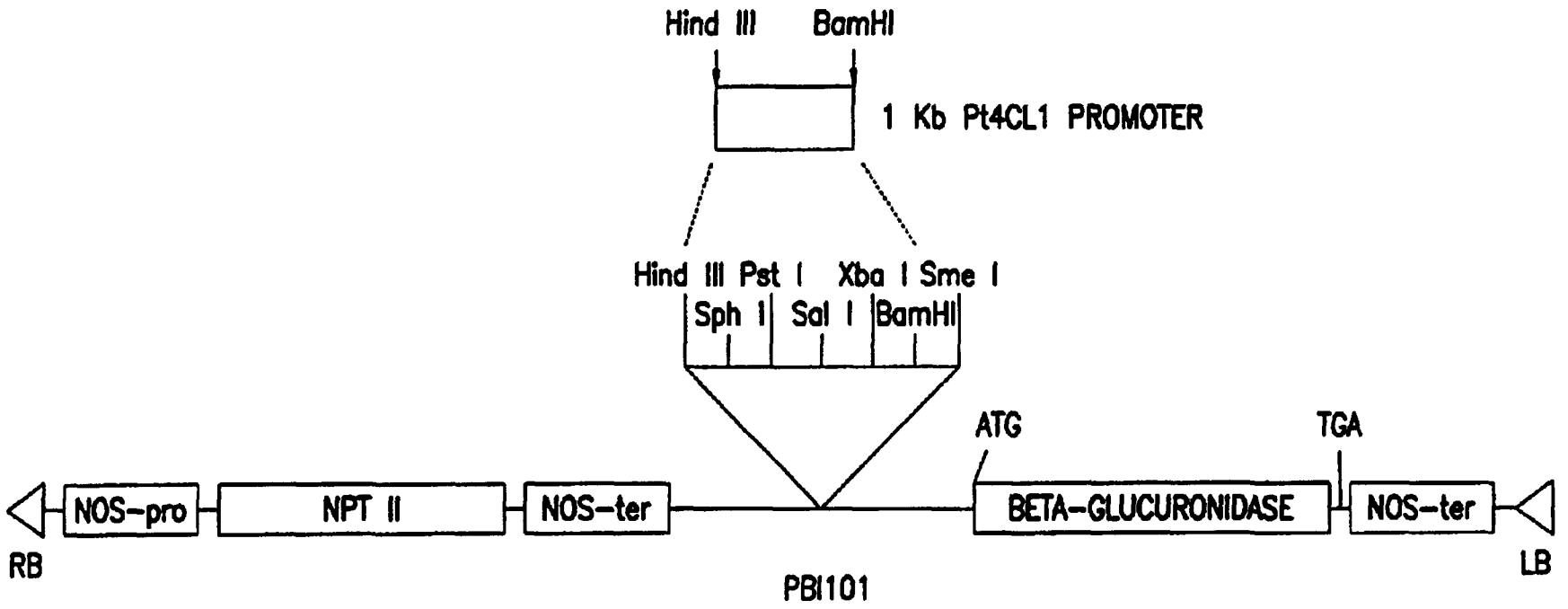

FIG. 7

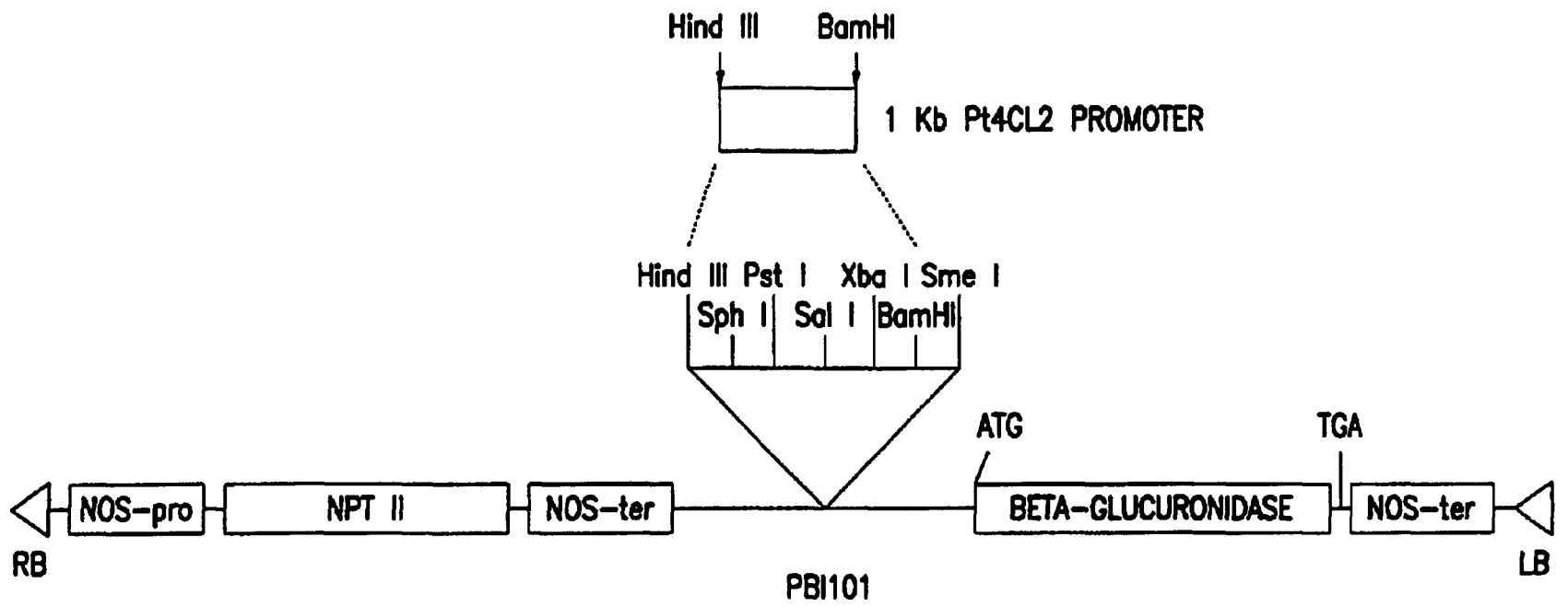

FIG. 8

1

## GENETIC ENGINEERING OF PLANTS THROUGH MANIPULATION OF LIGNIN BIOSYNTHESIS

### CROSS-REFERENCE TO RELATED APPLICATIONS

This application is a divisional of U.S. patent application Ser. No. 08/969,046, filed Nov. 12, 1997, now U.S. Pat. No. 6,455,762, issued Sep. 24, 2002.

### STATEMENT OF GOVERNMENT RIGHTS

The present invention was made at least in part with the support of the United States Government awarded by a grant from the U.S. Department of Agriculture (Grant No. 95-37103-2061). Therefore, the Government may have certain rights in the invention.

### FIELD OF THE INVENTION

The invention relates to genetically modifying trees through manipulation of the lignin biosynthesis pathway, and more particularly, to genetically modifying trees through the down regulation of p-coumarate Co-enzyme A ligase (CCL) to achieve faster growth, and/or altered lignin content, and/or altered lignin structure, and/or altered cellulose content and/or disease resistance of the trees and to the use of promoters of the CCL genes to drive gene expression specifically in xylem tissue or specifically in epidermal tissues.

### BACKGROUND OF THE INVENTION

Genetic engineering of forest tree species to conform to desired traits has shifted the emphasis in forest tree improvement away from the traditional breeding programs during the past decade. Although research on genetic engineering of forest trees has been vigorous, the progress has been slow due.

The ability to make trees grow faster and be disease resistant to produce the highest volume of wood in the shortest period of time has been and continues to be the top objective of many forest products company worldwide. The ability to genetically increase the optimal growth of trees would be a commercially significant improvement. Faster growing trees could be used by all sectors of the forest and wood products industry worldwide.

Lignin, a complex phenolic polymer, is a major component in cell walls of secondary xylem. In general, lignin constitutes 25% of the dry weight of the wood, making it the second most abundant organic compound on earth after cellulose. Although lignin plays an important role in plants, it usually represents an obstacle to utilizing biomass in several applications. For example, in woodpulp production, lignin has to be removed through expensive and polluting processes in order to recover cellulose.

Thus, it is desirable to genetically engineer plants with reduced lignin content and/or altered lignin composition that can be utilized more efficiently. Trees that could be genetically engineered with a reduced amount of lignin would be commercially valuable. These genetically engineered trees would be less expensive to pulp because, in essence, part of the pulping has already been performed due to the reduced amount of lignin.

Trees with increased cellulose content would also be commercially valuable to the pulp and paper industry.

Disease resistance in plants is also a most desirable plant trait. The impact of disease resistance in trees on the economy of forest products industry worldwide is significant.

2

Promoters that target specific plant tissue could be useful in manipulating gene expression to enable the engineering of traits of interest in specific tissue of plants, such as, xylem and epidermal tissues.

Although studies have revealed several general properties of plant p-coumarate Co-enzyme A ligase (CCL), the role of CCL in regulating the synthesis of monolignols in response to different states of development and environmental stress in tree species remains largely unknown. Furthermore, multiple CCL isoforms are normally present in plants, channeling phenolic compounds to the biosynthesis of not only lignin but also other phenylpropanoids, such as flavonoids. Since CCL isoforms have not been previously cloned from tree species for the identification of their biochemical functions, the presence of CCL isoforms remains so far as a challenge to a specific control of metabolic flux to the lignin biosynthesis in tree species.

### SUMMARY OF THE INVENTION

The invention provides a method to genetically alter trees through the down regulation of p-coumarate Co-enzyme A ligase (CCL). Such down regulation of CCL results in faster growth, and/or reduced lignin content, and/or altered lignin structure, and/or altered cellulose content and/or disease resistance. The invention also provides for genetically engineered trees which have been altered to down regulate p-coumarate Co-enzyme A ligase (CCL) to achieve faster growth, and/or reduced lignin content, and/or altered lignin structure, and/or increased cellulose content and/or increased disease resistance. The invention also provides tissue specific promoters of the CCL genes that can be used to manipulate gene expression in target tissue such as xylem and epidermal tissues.

It is one object of the present invention to down regulate p-coumarate Co-enzyme A ligase (CCL) in trees.

It is another object of the present invention to provide a method to genetically alter trees to grow faster.

It is another object of the present invention to provide a method to genetically alter the growth of trees through manipulation the lignin pathway p-coumarate Co-enzyme A ligase.

It is another object of the present invention to provide genetically altered trees with an accelerated growth characteristic.

It is another object of the present invention to provide transgenic trees with an accelerated growth characteristic which have been genetically altered by down regulating lignin pathway p-coumarate Co-enzyme A ligase.

It is another object of the present invention to provide a method to genetically alter trees to reduce their lignin content.

It is another object of the present invention to provide a method to genetically alter the lignin content of trees through manipulation of a lignin pathway enzyme.

It is another object of the present invention to genetically engineer trees which have reduced lignin content through manipulation of lignin pathway p-coumarate Co-enzyme A ligase.

It is another object of the present invention to provide genetically altered trees with a reduced lignin content.

It is another object of the present invention to provide transgenic trees with reduced lignin content which have been genetically altered by down regulating the p-coumarate Co-enzyme A ligase (CCL).

It is another object of the present invention to provide a method to genetically alter trees to change their lignin

## 3

structure through manipulation of lignin pathway p-coumarate Co-enzyme A ligase.

It is another object of the present invention to provide trees with altered lignin structure.

It is another object of the present invention to provide a method to increase the cellulose content in trees.

It is another object of the present invention to provide a method to increase the cellulose content of trees through the manipulation of a lignin pathway enzyme.

It is another object of the present invention to provide trees with increased cellulose content.

It is another object of the present invention to provide transgenic trees having increased cellulose content from the down regulation of CCL.

It is another object of the present invention to provide a method to genetically alter trees to increase their disease resistance.

It is another object of the present invention to provide a method to genetically alter trees to be more disease resistant through manipulation of the lignin pathway p-coumarate Co-enzyme A ligase.

It is another object of the present invention to genetically alter trees to increase their disease resistance to fungal pathogens.

It is another object of the present invention to provide trees with increased disease resistance.

It is another object of the present invention to provide transgenic trees with increased disease resistance through down regulation of the lignin pathway p-coumarate Co-enzyme A ligase.

It is another object of the present invention to provide a method using a promoter of a CCL gene to target gene expression in specific plant tissue.

It is another object of the present invention to provide a method using a promoter of a CCL gene to target gene expression specifically in plant xylem.

It is another object of the present invention to provide a method using a promoter of the CCL gene to target gene expression specifically in the epidermal tissues of plants.

It is another object of the present invention to provide a CCL gene promoter that targets gene expression specifically in the xylem of plants.

It is another object of the present invention to provide a CCL gene promoter that targets gene expression specifically in the epidermal tissues of plants.

Other features and advantages of the invention will become apparent to those of ordinary skill in the art upon review of the following drawing, detailed description and claims.

#### BRIEF DESCRIPTION OF THE DRAWINGS

FIG. 1 is a schematic of a phenylpropanoid pathway;

FIG. 2 is a diagram of *Agrobacterium* T-DNA construct pACCL1;

FIG. 3 is a restriction map of genomic clone PtCCL1g-4;

FIG. 4 is a restriction map of genomic clone PtCCL2g-11;

FIG. 5 is a restriction map of subcloned PtCCL1 gene promoter p7Z-4XS;

FIG. 6 is a restriction map of subcloned PtCCL2 gene promoter pSK-11HE

FIG. 7 is an *Agrobacterium* T-DNA construct of PtCCL1 promoter and GUS fusion gene, PtCCL1p-GUS; and

FIG. 8 is an *Agrobacterium* T-DNA construct of PtCCL2 promoter and GUS fusion gene, PtCCL2p-GUS.

## 4

Before one embodiment of the invention is explained in detail, it is to be understood that the invention is not limited in its application to the details set forth in the following description of the preferred embodiment. The invention is capable of other embodiments and of being practiced or being carried out in various ways. Also, it is to be understood that the phraseology and terminology used herein is for the purpose of description and should not be regarded as limiting.

#### DETAILED DESCRIPTION OF THE PREFERRED EMBODIMENT

The invention pertains to genetically down regulating a lignin pathway p-coumarate Co-enzyme A ligase (CCL). Trees which have been genetically transformed to down regulate CCL will hereafter be called transgenic trees. Such down regulation can result in faster growing trees. Such down regulation can result in a reduction in the lignin content of the trees and/or altered lignin structure. Such down regulation can result in increased cellulose content. Such down regulation can result in increased tree disease resistance. Further, by using a specific promoter of CCL, targeted tissue gene expression can be achieved in either the xylem or the epidermal tissues of the plant.

##### A. CCL

Lignin is synthesized by the oxidative coupling of three monolignols (coumaryl, coniferyl and sinapyl alcohols) formed via the phenylpropanoid pathway as shown in FIG. 1. Reactions in the phenylpropanoid pathway include the deamination of phenylalanine to cinnamic acid followed by hydroxylations, methylations and activation of substituted cinnamic acids to coenzyme A (CoA) esters. The CoA esters are then reduced to form monolignols which are secreted from cells to form lignin.

The products of the phenylpropanoid pathway are not only required for the synthesis of lignin but also required for the synthesis of a wide range of aromatic compounds including flavonoids, phytoalexins, stilbenes and suberin.

In angiosperms (hardwoods), lignin is composed of both coniferyl and sinapyl alcohol and is classified as guaiacyl-syringyl lignin. Grasses synthesize a third precursor (p-coumaryl alcohol) which is polymerized along with coniferyl and sinapyl alcohol. In gymnosperms (softwoods), lignin is composed of mainly coniferyl alcohol and is classified as guaiacyl lignin.

In the phenylpropanoid pathway, CCL activates a number of cinnamic acid derivatives, including p-coumaric acid, caffeic acid, ferulic acid, 5-hydroxyferulic acid and sinapic acid. The resulting products, CoA esters, serve as substrates for entry into various branch pathways, such as lignin, flavonoids, phytoalexins, stilbenes and suberin. The esterification reactions catalyzed by CCL require high energy and the reactions are not likely to occur without CCL. CCL is important in making a continuous flow of the lignin biosynthesis pathway. CCL is also important because it is located at the branching points of the phenylpropanoid metabolism. CCL is suggested to play a pivotal role in regulating carbon flow into specific branch pathways of the phenylpropanoid metabolism in response to stages of development and environmental stress.

The basic properties of CCL are quite uniform. CCL depends on ATP as a cosubstrate and requires  $Mg^{2+}$  as a cofactor. The optimal pH for CCL ranges from pH 7.0 to 8.5 and the molecular weight of CCL isoforms from various plant species ranges from 40 kd to 75 kd. Most CCLs have high affinity with substituted cinnamic acids. CCL has the highest activity with p-coumaric acid.

CCL cDNA sequences have been reported for parsley, potato, soybean, loblolly pine, *Arabidopsis*, *Lithospermum* and tobacco. CCL genes have been isolated and sequenced for parsley, rice, potato and loblolly pine. The analysis of CCL cDNAs and genes indicates that CCL is encoded by multiple/divergent genes in rice, soybean, and *Lithospermum*, very similar genes in parsley, potato, tobacco and loblolly pine, and a single gene in *Arabidopsis*. CCL promoters have been isolated and sequenced for parsley, rice and potato.

Alignment of deduced amino acid sequences of cloned plant CCL sequences reveals two highly conserved regions. The first conserved region (SSGTTGLPKGV),(SEQ ID NO:7) proposed to designate a putative AMP-binding region, is very rich in Gly, Ser and Thr and is followed by a conserved Lys. The second conserved region (GEICIRG), (SEQ ID NO:8) contains one common Cys residue. The amino acid sequences of CCL from plants contain a total of five conserved Cys residues.

The CCL genes of parsley, potato and rice contain five exons and four introns. The CCL genes also share the same exon/intron splice junction sites but have different lengths of introns. The genomic sequences of loblolly pine CCL are composed of four exons and three introns. It has been found that two similar CCL genes of the same species may differ slightly in length of intron as shown in two parsley genes (PC4CL1 and PC4CL2) and in two loblolly pine genes (LP4CL1 and LP4CL2).

By Northern blot analysis, it has been shown that CCL is expressed in leaf, shoot tip, stem, root, flower and cell culture. Two similar CCL cDNAs in parsley, potato and tobacco have been shown to be expressed at similar level in response to the environmental stress and during different developmental stages. Two distinct CCL cDNAs in soybean and *Lithospermum* have shown different expression levels when pathogens or chemicals were applied to the cell cultures. It appears that the expression of the CCL genes is developmentally regulated and inducible by many environmental stresses at the transcription level.

Genetic transformation with a CCL sequence can result in several significant affects. The description of the invention hereafter refers to aspen, and in particular quaking aspen (*Populus tremuloides* Michx) when necessary for the sake of example. However, it should be noted that the invention is not limited to genetic transformation of aspen. The method of the present invention is capable of being practiced for other trees, including for example, other angiosperms, other gymnosperm forest tree species, etc.

Preferably, the CCL down regulation is accomplished through transformation with a homologous CCL sequence in an antisense orientation. However, it should be noted that a heterologous antisense CCL sequence could be utilized and incorporated into a tree species to down regulate CCL if the heterologous CCL gene sequence has a high nucleotide sequence homology, approximately higher than 70%, to the endogenous CCL gene sequence of that tree species.

In addition, trees transformed with a sense CCL sequence could also cause a sequence homology-based cosuppression of the expression of the transgene and endogenous CCL gene, thereby achieving down regulation of CCL in these trees.

#### B. Isolation of CCL cDNAs

The present invention utilizes a homologous CCL sequence to genetically alter trees. The preferred embodiment of the invention as further described below utilizes a cDNA clone of the quaking aspen CCL gene.

Two aspen (*Populus tremuloides* Michx) cDNAs encoding two distinct CCL isoforms, PtCCL1 and PtCCL2 have

been cloned. PtCCL1 cDNA is lignin pathway-specific and is different from PtCCL2 cDNA, which is involved in flavonoid synthesis. The cloning of PtCCL1 and PtCCL2 cDNAs and the identification of their biochemical functions will be discussed in more length below. PtCCL1 and PtCCL2 genomic clones including their 5'-end regulatory promoter sequences were also isolated. The promoter of PtCCL1 (PtCCL1p) directs xylem tissue-specific gene expression in a plant, whereas the promoter of PtCCL2 (PtCCL2p) drives the expression of genes specifically in epidermal tissues of stem and leaf of a plant. These tissue specific promoters will be discussed in more length in Section I below.

Two CCL cDNAs, PtCCL1 and PtCCL2, have been isolated from quaking aspen using either a conventional cDNA library screening method or a PCR-based cDNA cloning method. It should be noted that the methods described below are set forth as an example and should not be considered limiting. These CCL cDNA clones are available from Michigan Technological University, Institute of Wood Research, Houghton, Mich.

Young leaves and shoot tips are collected from greenhouse-grown quaking aspen (*Populus tremuloides* Michx). Differentiating xylem and sclerenchyma are collected from three to four year old quaking aspen. The bark is peeled from the tree exposing the developing secondary xylem on the woody stem and the sclerenchyma on the inner side of the bark. Developing secondary xylem and sclerenchyma are scraped from the stem and bark with a razor blade and immediately frozen in liquid nitrogen until use.

Total RNA is isolated from the young leaves, shoot tips, xylem and sclerenchyma following the method of Bugos RC et al. (1995), RNA Isolation from Plant Tissue Recalcitrant to Extraction in Guanidine, *Biotechniques* 19(5):734-737. Poly(A)<sup>+</sup>RNA is purified from total RNA using Poly(A)<sup>+</sup> mRNA Isolation Kit from Tel-test B, Inc. A unidirectional Lambda gt22 expression cDNA library was constructed from the xylem mRNA using Superscript S System from Life Technologies, Inc. and Gigapack Packaging Extracts from Stratagene. The PtCCL1 cDNA was obtained by screening the cDNA library with a <sup>32</sup>P-labeled parsley 4CL cDNA probe. The parsley 4CL cDNA (pc4CL2) has Genbank accession number X13325, (SEQ ID NO:15).

The PtCCL2 cDNA was obtained by RT-PCR. The reverse transcription of total RNA isolated from shoot tips was carried out using the Superscript II reverse transcriptase from Life Technologies. Two sense primers (R1S, 5'-TTGGATCCGGIACIACIGGIYICCIAARGG-3' (SEQ ID NO:9) and H1S, 5'-TTGGATCCGTIGCICARCARGTIGAYGG-3' (SEQ ID NO:10)) are designed around the first consensus AMP-binding region of CCL that was previously discussed. One antisense primer (R2A, 5'-ATGTCGACCICGDATRCADATYTCICC-3') (SEQ ID NO:11) is designed based on the sequence of the putative catalytic motif GEICIRG (SEQ ID NO:8). One fifth of the reverse transcription reaction (4 TI) is used as the template in a 50 TI PCR reaction containing 1x reaction buffer, 200 TM each deoxyribonucleotide triphosphate, 2 TM each R1S and oligo-dT (20 mer) primers, and 2.5 units of Taq DNA polymerase. The PCR reaction mixture was denatured at 940 C for 5 minutes followed by 30 cycles of 940 C/45 seconds, 500 C/1 minute, 720 C/90 seconds and is ended with a 5 minute extension at 720 C. 2 TI of the PCR amplification products are used for a second run PCR re-amplification using primers H1S and R2A. A 0.6 kb PCR fragment is cloned using the TA Cloning Kit from Invitrogen and used



as a probe to screen an aspen genomic library to obtain the PtCCL2 genomic clone. Two primers (2A, 5'-TCTGTC TAGATGATGTCGTGGCCACGG-3' (SEQ ID NO:12) and 2B, 5'-TTAGATCTCTAGGACATGGTGGTGGC-3' (SEQ ID NO:13)) are designed based on the genomic sequence of PtCCL2 at around the deduced transcription start site and stop codon for the cloning of PtCCL2 cDNA by RT-PCR as described above using total RNA isolated from shoot tips.

The DNA sequences of PtCCL1 and PtCCL2 cDNA were determined using—Taq Cycle Sequencing Kit from Amersham.

The PtCCL1 cDNA has an open reading frame of 1620 bp which encodes a polypeptide of 540 amino acid residues with a predicted molecular weight of 59 kd and pI of 5.8. The nucleotide sequence of the aspen CCL cDNA clone PtCCL1 is set forth as SEQ ID NO:1. The deduced amino acid sequence for the aspen CCL1 protein is set forth as SEQ ID NO:2.

The PtCCL2 cDNA has an open reading frame of 1713 bp which encodes a polypeptide of 571 amino acid residues with a predicted molecular weight of 61.8 kd and pI of 5.1. The nucleotide sequence of the aspen CCL cDNA clone PtCCL2 is set forth as SEQ ID NO:3. The deduced amino acid sequence for the aspen CCL2 protein is set forth as SEQ ID NO:4.

The aspen PtCCL1 cDNA shares a 59–74% identity at the nucleotide level and 59–81% identity at the amino acid level with other prior reported CCL cDNAs and genes, whereas the PtCCL2 cDNA shares a 60–73% identity at the nucleotide level and 57–74% at the amino acid level with other CCL cDNAs and genes as set forth in the following table.

TABLE 1

Comparison of PtCCL1 and PtCCL2 Nucleotide and Predicted Amino Acid Sequence to Each Other and Other CCL Sequences				
cDNA*	DNA IDEN- TITY %	DNA IDENTITTY %	AMINO ACID IDENTITTY %	AMINO ACID IDENTITTY %
	PtCCL1	PtCCL2	PtCCL1	PtCCL2
PtCCL1		62		63
LE4CL1	69	62	71	64
LE4CL2	60	71	59	73
GM14	74	67	81	69
GM16	62	73	65	73
NT4CL1	67	62	75	74
NT4CL2	66	63	75	66
PC4CL1	66	64	71	64
PC4CL2	66	63	72	64
ST4CL1	67	63	75	64
AT4CL	66	63	70	61
LP4CL	61	64	63	67
OS4CL1	59	60	59	57

\*PtCCL1: aspen CCL

PtCCL2: aspen CCL

LE4CL1 and LE4CL2: *Lithospermum erythrorhizon* CCL

GM14 and GM16: soybean CCL

NT4CL1 and NT4CL2: tobacco CCL

PC4CL1 and PC4CL2: parsley CCL

ST4CL1: potato CCL

AT4CL: Arabidopsis CCL

LP4CL: loblolly pine CCL

OS4CL1: rice CCL

The results of sequence analysis, phylogenetic tree and genomic Southern blot analysis indicate that PtCCL1 and PtCCL2 cDNAs encode two distinct CCLs that belong to two divergent gene families in aspen. The deduced amino acid sequence for the PtCCL2 protein contains a longer N-terminal sequence than the PtCCL1 protein but shows

profound similarity in the central and C-terminal portions of protein to the PtCCL1 protein.

PtCCL1 and PtCCL2 cDNAs display distinct tissue-specific expression patterns. The PtCCL1 sequence is expressed highly in the secondary developing xylem and in the 6th to 10th internodes whereas the PtCCL2 sequence is expressed in the shoot tip and leaves. These tissue-specific expression patterns were investigated by fusing promoters of PtCCL1 and PtCCL2 genes to a GUS reporter gene. The tissue specific promoters for PtCCL1 and PtCCL2 will be discussed in more length in Section I below.

The substrate specificity of PtCCL1 and PtCCL2 is also different from each other as determined using recombinant proteins produced in *E. Coli*. PtCCL1 utilized p-coumaric acid, caffeic acid, ferulic acid and 5-hydroxyferulic acid as substrates. PtCCL2 showed activity to p-coumaric acid, caffeic acid and ferulic acid but not to 5-hydroxyferulic acid.

Specifically, PtCCL1 and PtCCL2 were used to construct expression vectors for *E.coli* expression. The substrate specificity of PtCCL1 and PtCCL2 were tested using fusion proteins produced in *E.coli*. Two plasmids, pQE/CCL1 and pQE/CCL2, were constructed in which the coding regions of PtCCL1 and PtCCL2, respectively were fused to N-terminal His tags in expression plasmids pQE-31 and pQE-32 (QIAGEN, Chatsworth, Calif.). The recombinant proteins of PtCCL1 and PtCCL2 produced by *E.coli* are approximately 59 kd and 63 kd, respectively.

The two recombinant proteins were tested for their activity in utilizing cinnamic acid derivatives. PtCCL1 recombinant protein showed 100, 58, 71, 18 and 0% relative activity to p-coumaric acid, caffeic acid, ferulic acid, 5-hydroxyferulic acid and sinapic acid, respectively. PtCCL2 recombinant protein exhibited 100, 14, 27, 0 and 0% relative activity to p-coumaric acid, caffeic acid, ferulic acid, 5-hydroxyferulic acid and sinapic acid, respectively. Neither recombinant protein showed detectable activity to sinapic acid.

The results of the tissue-specific expression pattern and substrate specificity suggests that in addition to the general function of CCL, PtCCL1 apparently is more related to lignin synthesis in the xylem tissue and PtCCL2 apparently is more likely involved in flavonoid synthesis and UV protection.

It should be noted that the isolation and characterization of the PtCCL1 and PtCCL2 cDNA clones is described in Kawaoka A, Chiang VL (1995), The Molecular Cloning and Expression of Syringyl- and Guaiacyl-Specific Hydroxycinnamate: CoA Ligases from Aspen (*Populus tremuloides*), Proceedings of the 6th International Conference on Biotechnology in the Pulp and Paper Industry, Vienna, Austria; and in Hu, Wen-Jing, Isolation and Characterization of p-coumarate Co-enzyme A ligase cDNAs and Genes from Quaking Aspen (*Populous tremuloides* Michx), Ph.D Dissertation, Michigan Technological University, Houghton, Mich. (1997); which are both herein incorporated by reference.

### C. Transformation and Regeneration

Several methods for gene transformation of plant species with the CCL sequence are available such as the use of a transformation vector, agroinfection, electroinjection, particle bombardment with a gene gun or microinjection.

Preferably, a CCL cDNA clone is positioned in a binary expression vector in an antisense orientation under the control of double cauliflower mosaic virus 35S promoter. The vector is then preferably mobilized into a strain of *Agrobacterium* species such as *tumefaciens* strain C58/pMP90 and is used as the DNA delivery system due to its efficiency and low cost.

For example, with reference to FIG. 2, the binary expression pACCL1 used for plant transformations is shown. Specifically, the pCCL1 cDNA is inserted in an antisense orientation into Pac I and BamH I sites between the double CaMV 35S/AMV RNA4 and the 3' terminator sequence of the nopaline synthase gene in a binary cloning vector pACCL1 (FIG. 2). The binary vector containing hygromycin phosphotransferase (HPT) gene is modified from pBin 19.

The gene construct pACCL1 is available from Michigan Technological University, Institute of Wood Research, Houghton, Mich.

The binary vector construct is mobilized in *Agrobacterium tumefaciens* using the freeze-thaw method of Holsters et al., Mol. Gen. Genet. 163:181-187 (1978). For the freeze-thaw method, 1.5 ml of overnight cultures *Agrobacterium tumefaciens* strain C58/pMP90 is pelleted at 5000×g for 3 minutes at 40 C and suspended in 1 ml of ice cold 20 mM CaCl<sub>2</sub>. To the suspension is added 10 μl binary vector DNA (from an alkaline lysis minipreparation) and mixed by pipetting. The microcentrifuge tube is then frozen in liquid nitrogen for 5 minutes and thawed at 370 C for 5 minutes. After being cooled on ice, 1 ml of LB is added and the mixture is incubated at 280 C for 2 hours with gentle shaking. 200 μl of the cells is spread onto LB plates containing gentamycin and kanamycin and incubated at 280 C for 2 days. Colonies grown on the selection plates are randomly picked or miniprep and restriction enzyme digestion analysis is used to verify the integration.

The resulting binary vector containing *Agrobacterium* strain is used to transform quaking aspen according to Tsai et al., *Agrobacterium*-Mediated Transformation of Quaking Aspen (*Populus tremuloides*) and Regeneration of Transgenic Plants, Plant Cell Rep. 14:94-97 as set forth below.

Explants of young leaves from cuttings of aspen are obtained by cutting leaf disks of approximately 7 mm square from the young leaves along the midrib of the leaves. The explants are surface sterilized in 20% commercial bleach for 10 minutes followed by rinsing 3 times with sterile double-distilled water.

All of the culture media used includes the basal medium of woody plant medium (WPM) as described in Lloyd et al., Proc. Int. Plant Prop. Soc. 30:421-437 (1980) and supplemented with 2% sucrose. 650 mg/L calcium gluconate and 500 mg/L MES are added as pH buffers as described in Tsai, Plant Cell Reports, 1994. All culture media is adjusted to pH 5.5 prior to the addition of 0.075% Difco Bacto Agar and then autoclaved at 1210 C and 15 psi for 20 minutes. Filter sterilized antibiotics are added to all culture media after autoclaving. All culture media are maintained at 23±10 C in a growth chamber with 16 hour photoperiods (1601E×m<sup>-2</sup>×S<sup>-1</sup>) except for callus induction (as will be described later) which is maintained in the dark.

The sterilized explants are then inoculated with the mobilized vector with an overnight-grown agrobacterial suspension containing 20 μM acetosyringone. After cocultivation for 2 days, the explants are washed in 1 mg/ml claforan and ticarcillin for 2 hours with shaking to kill *Agrobacterium*. The explants are blotted dry with sterile Whatman No. 1 filter paper and transferred onto callus induction medium containing 50 mg/L kanamycin and 300 mg/L claforan to induce and select transformed callus. The callus induction medium is the basal medium with the addition of 6-benzyladenine (BA) and 2,4-dichlorophenoxyacetic acid (2,4-D) at concentrations of 0.5 mg/L and 1 mg/L, respectively, to induce callus.

The kanamycin-resistant explants are then subcultured on fresh callus induction media every two weeks. Callus for-

mation occurs after approximately four weeks. Formed callus are separated from the explant and subcultured periodically for further proliferation.

When the callus clumps reach approximately 3 mm in diameter, the callus clumps are transferred to shoot regeneration medium. The shoot regeneration medium is the basal medium containing 50 mg/L kanamycin, 0.5 mg/L thidiazuron (TDZ) as a plant growth regulator and cefotaxime at 300 mg/L to kill *Agrobacterium*. Shoots were regenerated about 4 weeks after callus is transferred to regeneration medium. As soon as the shoots are regenerated, they are immediately transferred to hormone-free elongation medium containing 50 mg/L kanamycin and, whenever necessary, cefotaxime (300 mg/L), to promote elongation. Green and healthy shoots elongated to 2-3 cm in length are excised and planted separately in a hormone-free rooting medium containing 50 mg/L kanamycin. The efficient uptake of kanamycin by shoots during their rooting stage provides the most effective selection for positive transformants. Transgenic plants are then transplanted into soil medium of vermiculite:peat-moss:perlite at 1:1:1 and grown in the greenhouse.

The above described transformation and regeneration protocol is readily adaptable to other tree species. Other published transformation and regeneration protocols for tree species include Danekar et al., Bio/Technology 5:587-590 (1987); McGranahan et al., Bio/Technology 6:800-804 (1988); McGranahan et al., Plant Cell Reports 8:512-616 (1990); Chen, PhD Thesis, North Carolina State University, Raleigh, N.C. (1991); Sullivan et al., Plant Cell Reports 12:303-306 (1993); Huang et al., In Vitro Cell Dev. Bio. 4:201-207 (1991); Wilde et al., Plant Physiol. 98:114-120 (1992); Minocha et al., 1986 Proc. TAPPI Research and Development Conference, TAPPI Press, Atlanta, pp. 89-91 (1986); Parsons et al., Bio/Technology 4:533-536 (1986); Fillatti et al., Mol. Gen. Genet 206:192-199 (1987); Pythoud et al., Bio/Technology 5:1323-1327 (1987); De Block, Plant Physiol. 93:1110-1116 (1990); Brasileiro et al., Plant Mol. Bio 17:441-452 (1991); Brasileiro et al., Transgenic Res. 1:133-141 (1992); Howe et al., Woody Plant Biotech., Plenum Press, New York, pp. 283-294 (1991); Klopfenstein et al., Can. J. For. Res. 21:1321-1328 (1991); Leple et al., Plant Cell Reports 11:137-141 (1992); and Nilsson et al. Transgenic Res. 1:209-220 (1992).

#### D. Phenotype Changes

The results of the transformation can be confirmed with conventional PCR and Southern analysis. For example, transferring CCL cDNA in an antisense orientation down regulates CCL in the tree. Expression of the CCL has been found to be blocked up to 96 percent in some transgenic trees.

After acclimation, the transgenic aspen display an unusual phenotype, including big curly leaves, thick diameters, longer internodes, more young leaves in the shoot tip and a red pigmentation in the petioles extending into midvein leaves. Red coloration of the developing secondary xylem tissues is observed after peeling of the bark in the transgenic plants.

#### E. Accelerated Growth

Down regulation of CCL alters growth of the transgenic trees. For example, transformation with an antisense CCL sequence accelerates the growth of the tree. Enhanced growth is markedly noticeable at all ages. In particular, the transgenic trees show enhanced growth in the form of thicker stems and enlarged leaves as compared to control trees. These characteristics are retained in the vegetative propagules of these transgenic trees. Table 2 sets forth exemplary data with respect to several lines of transgenic

11

quaking aspen grown in the greenhouse after eight months. Volume represents the overall quantitative growth of the tree.

TABLE 2

Growth Measurement for Control and Transgenic Plants				
PLANT #	HEIGHT (cm)	DIAMETER (cm)*	VOLUME (cm <sup>3</sup> )*	AVERAGE LENGTH OF INTERNODE (cm)
Control 1	247.7	1.08	75.6	2.6
Control 2	250.2	1.01	66.8	2.8
11-1	304.8	1.15	105.5	3.1
11-2	248.9	1.01	66.4	3.4
11-3	241.3	0.84	44.6	3.2
11-4	288.3	0.94	66.7	3.4
11-5	246.4	0.92	54.6	3.3
11-7	226.7	1.13	75.7	3.4
11-8	289.6	1.16	102.0	3.3
11-9	287.0	1.76	232.6	4.3
11-10	252.7	0.83	45.6	3.1
11-11	247.7	0.86	48.0	3.5
12-1	247.7	1.1	78.4	2.7
12-2	199.4	0.96	48.1	2.5
12-6	294.6	0.92	65.2	3.2
16-1	227.3	0.95	53.7	2.8
16-2	278.1	0.97	68.5	3.4
16-3	265.4	1.09	82.5	3.5
17-2	243.8	0.89	50.5	2.6

\*at 10 cm above ground

The averages for height, diameter, volume and average length between internodes for the control plants are as follows:

Height (cm)	248.95
Diameter (cm)	1.045
Volume (cm <sup>3</sup> )	71.2
Ave. Length of Internodes (cm)	2.7

With respect to height alone, for those transgenic plants (11-1, 11-4, 11-8, 11-9, 12-6, 16-2, 16-3) having a statistically larger height than the control plants, the average height was 286.83 cm as compared to the control plant average height of 248.95 cm.

With respect to diameter alone, for those transgenic plants (11-1, 11-7, 11-8, 11-9) having a statistically larger diameter than the control plants, the average diameter was 1.30 cm as compared to the control plant average diameter of 1.045 cm.

With respect to volume alone, for those transgenic plants (11-1, 11-8, 11-9, 12-1, 16-3) having a statistically larger volume than the control plants, the average volume was 120.2 cm<sup>3</sup> as compared to the control plant average volume of 71.2 cm<sup>3</sup>.

With respect to average length of internodes alone, for those transgenic plants (11-1, 11-2, 11-3, 11-4, 11-5, 11-7, 11-8, 11-9, 11-10, 12-6, 16-2, 16-3) having a statistically larger average length of internodes than the control plants, the average average length of internodes was 3.39 cm as compared to the control plant average average length of internodes of 2.70 cm.

As demonstrated in Table 2, while there are variations in growth among the transgenic trees, the average length of the internodes for the transgenic trees is consistently and significantly higher than that of the control plants. Variations in the growth of the transgenic trees is normal and to be expected. Preferably, a transgenic tree with a particular growth rate is selected and this tree is vegetatively propa-

12

gated to produce an unlimited number of clones that all exhibit the identical growth rate.

F. Lignin

5 Down regulation of lignin pathway CCL results in production of trees with reduced lignin content.

The following table shows the reduction of lignin content and CCL enzyme activity in several transgenic aspen which have been transformed with an homologous antisense CCL sequence.

TABLE 3

Characterization of Transgenic Aspen Plants Harboring Antisense CCL Sequence				
Transgenic Plant #	Lignin Content % Based On		CCL Enzyme Activity*	% CCL Enzyme Activity Reduction
	Wood Weight	% Lignin Reduction		
control	21.4	0.0	868	0
11-1	20.5	4.2	1171	-25
11-2	19.2	10.3	515	45
11-3	20.9	2.3	922	6
11-4	19.7	7.9	1032	-19
11-5	19.7	7.9	691	20
11-7	19.9	7.0	578	38
11-8	20.2	5.6	694	20
11-9	20.4	4.7	806	14
11-10	19.4	9.3	455	51
11-11	20.4	4.7	726	22
12-1	12.8	40.2	49	95
12-2	12.6	41.1	62	93
12-3	11.9	44.4	61	94
12-6	19.8	7.5	786	16
16-1	12.8	40.2	35	96
16-2	20.6	3.7	780	17
16-3	21.0	1.9	795	15
17-1	20.5	4.2	855	9
17-2	21.4	0.0	925	1

\*activity is expressed as pkat/(mg protein) using p-coumaric acid as the substrate

Lignin content was determined according to Chiang and Funaoka (1990) *Holzforchung* 44:147-155. CCL enzyme activity was determined according to Ranjeva et al. (1976), *Biochimie* 58:1255-1262.

The data in Table 3 demonstrates a correlation between down regulation of CCL and reduction in lignin content.

Transgenic trees with reduced lignin content have an altered phenotype in that the stem is more elastic to the touch and the leaves are typically curlier.

It should also be noted that for those transgenic trees (12-1, 12-2, 12-3 and 16-1) with the approximately 40% reduction in lignin content and the corresponding approximately 95% reduction in CCL enzyme levels, all of those transgenic trees had a consistent deep red coloration in the wood of the plant. Accordingly, the deep red color can be used as an identifier of reduced lignin content.

Down regulation of lignin pathway CCL also results in production of trees with an altered lignin structure. Based upon thioacidolysis (Rolando et al. (1992) *Thioacidolysis, Methods in Lignin Chemistry*, Springer-Verlag, Berlin, pp 334-349) of plants 12-3 and 16-1, coniferyl alcohol and sinapyl alcohol lignin units are significantly reduced in these two trees as compared to the control tree, as shown in the following table.

TABLE 4

Plant #	Altered Lignin Structure	
	Coniferyl Alcohol Units*	Sinapyl Alcohol Units*
control	733	1700
12-3	283	592
16-1	247	445

\*micro-mole/g of lignin

The alteration of the frequency of the structural units in lignin of these transgenic trees is evidence that the overall structure of lignin in these plants has been genetically altered.

#### G. Cellulose Content

Down regulation of lignin pathway CCL results in increased cellulose content of the transgenic plants. Analysis of control and transgenic aspen for carbohydrate content demonstrate a higher cellulose content in the transgenic trees than the control trees. Particularly, the transgenic trees that have over 40% lignin reduction have about 10–15% higher cellulose content than the control. Data is set forth in the following tables for trees that were transformed with homologous CCL in an antisense orientation:

TABLE 5

Plant #	Analysis of Carbohydrate Components in Transgenic and Control Aspen					
	Glucan	Arabinan	Galactan	Rhamnan	Xylan	Mannan
Control	44.23%	0.47%	0.79%	0.37%	17.19%	1.91%
11-2	49.05%	0.36%	1.05%	0.38%	15.34%	2.04%
11-9	45.95%	0.40%	0.80%	0.37%	17.12%	1.83%
11-10	47.49%	0.43%	0.99%	0.40%	16.24%	2.35%
12-3	50.83%	0.55%	1.24%	0.48%	17.25%	1.77%
16-1	48.14%	0.56%	1.07%	0.48%	19.14%	1.58%
16-2	46.55%	0.34%	0.82%	0.37%	16.75%	2.31%

TABLE 6

Plant #	Comparison of Lignin and Cellulose (glucan) Contents in Transgenic and Control Aspen			
	Lignin		Cellulose	
	Content % on wood	% reduction	Content % on wood	% increase
Control	21.4	0	44.23	0
11-2	19.2	10.3	49.05	11.0
11-9	20.4	4.7	45.95	3.9
11-10	19.4	9.3	47.49	7.4
12-3	11.9	44.5	50.83	15.0
16-1	12.8	40.2	48.14	8.8
16-2	20.6	3.7	46.55	5.2

The procedure for carbohydrate analysis utilized is as follows. About 100 mg of powdery woody tissue with sizes that pass a 80-mesh screen was hydrolyzed with 1 mL of 72% (W/W) H<sub>2</sub>SO<sub>4</sub> for 1 hr at 300 C. Samples were then diluted to 4% (W/W) H<sub>2</sub>SO<sub>4</sub> with distilled water, fucose was added as an internal standard, and a secondary hydrolysis was performed for 1 hr at 1210 C. After secondary hydrolysis, the sugar contents of the hydrolysates are determined by anion exchange high performance liquid chromatography using pulsed amperometric detection. Sugar contents are expressed as % of the weight of the woody tissue

used. The above procedures are similar to those in a publication by R C Pettersen and V H Schwandt, 1991, J. Wood Chem & Technol. 11:495–501.

#### H. Increased Disease Resistance

5 Down regulation of lignin pathway CCL results in production of trees with increased disease resistance, and in particular, with increased fungal pathogen resistance.

In particular, greenhouse transgenic aspen plants showed a disease resistance to fungi such as those which induce leaf-blight disease.

#### I. Promoters

Two distinct genes encoding CCL and their promoters were cloned. The promoter of PtCCL1 can drive gene expression specifically in xylem tissue and the promoter for PtCCL2 confers gene expression exclusively in the epidermal tissues. These promoters can be used to manipulate gene expression to engineer traits of interest in specific tissues of target plants. The significance of the promoters is the application of the xylem-specific promoter to direct the expression of any relevant genes specifically in the xylem for engineering lignin content, lignin structure, enhanced tree growth, cellulose content and other value-added wood qualities, etc. The importance of the epidermis-specific promoter is its ability to drive the expression of any relevant genes specifically in epidermal tissues for engineering disease-, UV light-, cold-, heat-, drought-, and other stress resistance traits in trees.

Specifically, the promoters of the PtCCL1 and PtCCL2 were conventionally isolated as follows. An aspen genomic library was screened with PtCCL1 cDNA and PtCCL2 partial cDNA fragment to isolate genomic clones of PtCCL1 and PtCCL2. Eleven and seven positive genomic clones were identified for PtCCL1 and PtCCL2 gene, respectively. Among 11 positive clones for PtCCL1, PtCCL1g-4 contained a full length coding sequence and at least 2 kb 5' flanking regions. The restriction map of PtCCL1g-4 is set forth at FIG. 3.

With respect to PtCCL2, restriction map analysis was performed on  $\lambda$ DNA of positive genomic clone PtCCL2g-11. The restriction map of PtCCL2g-11 is set forth at FIG. 4.

Approximately a 2.3 kb 5' flanking region of PtCCL1 was digested from PtCCL1g-4 using Xba I and Sac I sites and cloned into pGEM7Z Xba I and Sac I sites. The subcloned PtCCL1 promoter was named p7Z-4XS and the restriction map of P7Z4XS is set forth at FIG. 5. The 5' unilateral deletion of p7Z-4XS was generated for DNA sequencing by exonuclease III/S1 nuclease digestion using Erase-a-Base System (Promega, Madison, Wis.). The deletion series was sequenced using a primer on pGEM7Z vector.

A 1.6 kb Hind III and EcoR I fragment containing a 1.2 kb 5' flanking region of PtCCL2 and 0.4 kb coding region of PtCCL2g-11 were subcloned in pBluescript II SK+ Hind III and EcoR I sites. The restriction map of the resulting clone, pSK-11HE, was determined by digesting the plasmid with several restriction enzymes, as in set forth at FIG. 6. In order to determine the sequence of the PtCCL2 promoter, pSK-11HE was further digested into small fragments according to the restriction map and subcloned into vectors with suitable cloning sites. The DNA sequence was determined using M13 universal primer and reverse primer on the vector.

The DNA sequences of the two promoters was determined and analyzed using qTaq cycle sequencing Kit (USB, Cleveland, Ohio), and GENETYX-MAC 7.3 sequence analysis software from Software Development Co., Ltd. The nucleotide sequence of promoter region of PtCCL1 is set forth as SEQ ID NO:5 and the nucleotide sequence of the promoter region of PtCCL2 is set forth as SEQ ID NO:6.

The promoter gene constructs PtCCL1p and PtCCL2p are available from Michigan Technological University, Institute of Wood Research, Houghton, Mich.

Tissue-specific expression can be achieved by conventionally fusing the promoters of PtCCL1 or PtCCL2 to a gene of interest and transferred to a plant species via *Agrobacterium*. For the sake of example, the promoters of PtCCL1 and PtCCL2 were fused to a GUS reporter gene as detailed below. However, it should be noted that genes other than the GUS reporter gene can be fused to these promoters for tissue specific expression.

In order to construct PtCCL1 promoter-GUS binary vector, a 1 Kb fragment covering 5'-flanking region and 117 bp coding region of PtCCL1 was subcloned into pGEM7Z Sph I and EcoR I sites for constructing promoter-GUS binary vector. In this 1 kb DNA fragment, it is found that one Xho I site locates at 486 bases proximal to the translation start site and the EcoR I site at 117 bases downstream the translation site. This 0.6 Kb fragment was subcloned into pGEM7Z Xho I and EcoR I sites and used as a template in PCR amplification.

In order to construct a promoter-GUS transcriptional fusion, a BamH I site was introduced in front of the translation start site of PtCCL1 by PCR. PCR amplification was performed using p7Z-4XE as the template, M13 universal primer on pGEM7Z vector as 5' end primer and PtCCL1p-1 primer containing a BamH I site at the end is complementary to a sequence upstream of the translation start site. The reaction was carried out in 100  $\mu$ l reaction mix containing 1xpfu reaction buffer, 200  $\mu$ l each dNTPs, 100  $\mu$ M each primer and 5 units of pfu. The PCR reaction mixture was denatured at 94 C for 5 minutes followed by 30 cycles of 94 C (1 minute), 55 C (1 minute), 72 C (1 minute, 30 seconds) and was ended with a 5 minute extension at 72C.

The amplified 0.6 Kb fragment was cloned and sequenced to confirm the sequence. The engineered 0.6 Kb fragment was ligated to p7Z-4SE which was digested with Xho I and BamH I. In order to incorporate a Hind III site in the 5' end of PtCCL1 promoter, the 1 kb Sph I-BamH I PtCCL1

promoter region was the cloned into pNoTA (5 prime $\rightarrow$ 3 prime Inc., Boulder, Colo.) Sph I and BamH I site. The 1 Kb PtCCL1 promoter was then released from pNoTA vector with Hind III and BamH digestion and subsequently transcriptionally fused to pBI101 Hind III and BamH I sites in front of GUS. The resulting binary vector was named PtCCL1p-GUS and is set forth at FIG. 7.

In order to construct PtCCL2 promoter-GUS binary vector, pSK-11HE was digested with Sph I and EcoR I to release 0.2 Kb Sph I and EcoR I fragment. The 0.2 Kb fragment was cloned into pGEM7Z Sph I and EcoR I sites. A primer, PtCCL2p-3' (5'-CATCGGATCCTGAGATGGAAGGGAGTKTCT-3' (SEQ ID NO:14)) was designed to be complementary to a sequence upstream of the translation start site of PtCCL2 and to incorporate BamH I site at the end. Amplification was performed using p7Z1 SE as a template, M13 universal primer as the 5' end primer and PtCCL2p-3 as the 3' end primer. A PCR reaction was carried out and the amplified PCR product was cloned and sequenced to check the fidelity of the PCR amplification. The 0.2 Kb Sph I-BamH I DNA fragment with correct sequence was fused to pSK-11HE linearized with Sph I and BamH I. The resulting plasmid was named pSK-11HB. The promoter of PtCCL2 was then excised from pSK-11HB with Hind III and BamH I and ligated to PBI101 Hind III and BamH I site to make PtCCL2p-GUS transcriptional fusion binary vector as shown in FIG. 8.

The PtCCL1p-GUS and PtCCL2p-GUS constructs are then mobilized into *Agrobacterium tumefaciens* strain C58/pMP90 by freeze and thaw method as explained previously.

Leaf disk transformation of tobacco with these two *Agrobacterium* constructs is conducted according to the method of Horsch R. B. (1988) Leaf Disk Transformation, Plant Molecular Biology Manual, A5:1-9. Histochemical GUS staining of promoter-GUS transgenic tobacco plants demonstrated that the PtCCL1 promoter restricted GUS expression in xylem tissue whereas PtCCL2 promoter regulated GUS expression in epidermal cells.

## SEQUENCE LISTING

<160> NUMBER OF SEQ ID NOS: 15

<210> SEQ ID NO 1

<211> LENGTH: 1915

<212> TYPE: DNA

<213> ORGANISM: Populus tremuloides Michx. (aspen)

<220> FEATURE:

<221> NAME/KEY: CDS

<222> LOCATION: (83)...(1687)

<400> SEQUENCE: 1

ccctcgcgaa actccgaaaa cagagagcac ctaaaactca ccatctctcc ctctgcatct 60

ttagcccgca atggacgcca ca atg aat cca caa gaa ttc atc ttt cgc tca 112  
Met Asn Pro Gln Glu Phe Ile Phe Arg Ser  
1 5 10

aaa tta cca gac atc tac atc ccg aaa aac ctt ccc ctg cat tca tac 160  
Lys Leu Pro Asp Ile Tyr Ile Pro Lys Asn Leu Pro Leu His Ser Tyr  
15 20 25

ggt ctt gag aac ttg tct aaa cat tca tca aaa cct tgc ctg ata aat 208  
Val Leu Glu Asn Leu Ser Lys His Ser Ser Lys Pro Cys Leu Ile Asn  
30 35 40

-continued

ggc gcg aat gga gat gtc tac acc tat gct gat gtt gag ctc aca gca	256
Gly Ala Asn Gly Asp Val Tyr Thr Tyr Ala Asp Val Glu Leu Thr Ala	
45 50 55	
aga aga gtt gct tct ggt ctg aac aag att ggt att caa caa ggt gac	304
Arg Arg Val Ala Ser Gly Leu Asn Lys Ile Gly Ile Gln Gln Gly Asp	
60 65 70	
gtg atc atg ctc ttc cta cca agt tca cct gaa ttc gtg ctt gct ttc	352
Val Ile Met Leu Phe Leu Pro Ser Ser Pro Glu Phe Val Leu Ala Phe	
75 80 85 90	
cta ggc gct tca cac aga ggt gcc atg atc act gct gcc aat cct ttc	400
Leu Gly Ala Ser His Arg Gly Ala Met Ile Thr Ala Ala Asn Pro Phe	
95 100 105	
tcc acc cct gca gag cta gca aaa cat gcc aag gcc tcg aga gca aag	448
Ser Thr Pro Ala Glu Leu Ala Lys His Ala Lys Ala Ser Arg Ala Lys	
110 115 120	
ctt ctg ata aca cag gct tgt tac tac gag aag gtt aaa gat ttt gcc	496
Leu Leu Ile Thr Gln Ala Cys Tyr Tyr Glu Lys Val Lys Asp Phe Ala	
125 130 135	
cga gaa agt gat gtt aag gtc atg tgc gtg gac tct gcc ccg gac ggt	544
Arg Glu Ser Asp Val Lys Val Met Cys Val Asp Ser Ala Pro Asp Gly	
140 145 150	
gct tca ctt ttc aga gct cac aca cag gca gac gaa aat gaa gtg cct	592
Ala Ser Leu Phe Arg Ala His Thr Gln Ala Asp Glu Asn Glu Val Pro	
155 160 165 170	
cag gtc gac att agt cct gat gat gtc gta gca ttg cct tat tca tca	640
Gln Val Asp Ile Ser Pro Asp Asp Val Val Ala Leu Pro Tyr Ser Ser	
175 180 185	
ggg act aca ggg ttg cca aaa ggg gtc atg tta acg cac aaa ggg cta	688
Gly Thr Thr Gly Leu Pro Lys Gly Val Met Leu Thr His Lys Gly Leu	
190 195 200	
ata acc agt gtg gct caa cag gta gat gga gac aat cct aac ctg tat	736
Ile Thr Ser Val Ala Gln Gln Val Asp Gly Asp Asn Pro Asn Leu Tyr	
205 210 215	
ttt cac agt gaa gat gtg att ctg tgt gtg ctt cct atg ttc cat atc	784
Phe His Ser Glu Asp Val Ile Leu Cys Val Leu Pro Met Phe His Ile	
220 225 230	
tat gct ctg aat tca atg atg ctc tgt ggt ctg aga gtt ggt gcc tcg	832
Tyr Ala Leu Asn Ser Met Met Leu Cys Gly Leu Arg Val Gly Ala Ser	
235 240 245 250	
att ttg ata atg cca aag ttt gag att ggt tct ttg ctg gga ttg att	880
Ile Leu Ile Met Pro Lys Phe Glu Ile Gly Ser Leu Leu Gly Leu Ile	
255 260 265	
gag aag tac aag gta tct ata gca cca gtt gtt cca cct gtg atg atg	928
Glu Lys Tyr Lys Val Ser Ile Ala Pro Val Val Pro Pro Val Met Met	
270 275 280	
gca att gct aag tca cct gat ctt gac aag cat gac ctg tct tct ttg	976
Ala Ile Ala Lys Ser Pro Asp Leu Asp Lys His Asp Leu Ser Ser Leu	
285 290 295	
agg atg ata aaa tct gga ggg gct cca ttg ggc aag gaa ctt gaa gat	1024
Arg Met Ile Lys Ser Gly Gly Ala Pro Leu Gly Lys Glu Leu Glu Asp	
300 305 310	
act gtc aga gct aag ttt cct cag gct aga ctt ggt cag gga tat gga	1072
Thr Val Arg Ala Lys Phe Pro Gln Ala Arg Leu Gly Gln Gly Tyr Gly	
315 320 325 330	
atg acc gag gca gga cct gtt cta gca atg tgc ttg gca ttt gcc aag	1120
Met Thr Glu Ala Gly Pro Val Leu Ala Met Cys Leu Ala Phe Ala Lys	
335 340 345	
gaa cca ttc gac ata aaa cca ggt gca tgt gga act gta gtc agg aat	1168
Glu Pro Phe Asp Ile Lys Pro Gly Ala Cys Gly Thr Val Val Arg Asn	

-continued

350	355	360	
gca gag atg aag att gtt gac cca gaa aca ggg gtc tct cta ccg agg			1216
Ala Glu Met Lys Ile Val Asp Pro Glu Thr Gly Val Ser Leu Pro Arg			
365	370	375	
aac cag cct ggt gag atc tgc atc cgg ggt gat cag atc atg aaa gga			1264
Asn Gln Pro Gly Glu Ile Cys Ile Arg Gly Asp Gln Ile Met Lys Gly			
380	385	390	
tat ctt aat gac ccc gag gca acc tca aga aca ata gac aaa gaa gga			1312
Tyr Leu Asn Asp Pro Glu Ala Thr Ser Arg Thr Ile Asp Lys Glu Gly			
395	400	405	410
tgg ctg cac aca ggc gat atc ggc tac att gat gat gat gag ctt			1360
Trp Leu His Thr Gly Asp Ile Gly Tyr Ile Asp Asp Asp Asp Glu Leu			
415	420	425	
ttc atc gtt gac aga ttg aag gaa ttg atc aag tat aaa ggg ttt cag			1408
Phe Ile Val Asp Arg Leu Lys Glu Leu Ile Lys Tyr Lys Gly Phe Gln			
430	435	440	
gtt gct cct act gaa ctc gaa gct ttg tta ata gcc cat cca gag ata			1456
Val Ala Pro Thr Glu Leu Glu Ala Leu Leu Ile Ala His Pro Glu Ile			
445	450	455	
tcc gat gct gct gta gta gga ttg aaa gat gag gat gcg gga gaa gtt			1504
Ser Asp Ala Ala Val Val Gly Leu Lys Asp Glu Asp Ala Gly Glu Val			
460	465	470	
cct gtt gca ttt gta gtg aaa tca gaa aag tct cag gcc acc gaa gat			1552
Pro Val Ala Phe Val Val Lys Ser Glu Lys Ser Gln Ala Thr Glu Asp			
475	480	485	490
gaa att aag cag tat att tca aaa cag gtg atc ttc tac aag aga ata			1600
Glu Ile Lys Gln Tyr Ile Ser Lys Gln Val Ile Phe Tyr Lys Arg Ile			
495	500	505	
aaa cga gtt ttc ttc att gaa gca att ccc aag gca cca tca ggc aag			1648
Lys Arg Val Phe Phe Ile Glu Ala Ile Pro Lys Ala Pro Ser Gly Lys			
510	515	520	
atc ctg agg aag aat ctg aaa gag aag ttg cca ggc ata taactgaaga			1697
Ile Leu Arg Lys Asn Leu Lys Glu Lys Leu Pro Gly Ile			
525	530	535	
tgttactgaa catttaaccc tctgtcttat ttctttaata cttgcgaatc attgtagtgt			1757
tgaaccaagc atgcttgga aagacagta cccaacgtaa gacagttact gttcctagta			1817
tacaagctct ttaatgttcg ttttgaactt gggaaaacat aagttctcct gtcgccatat			1877
ggagtaattc aattgaatat tttggtttct ttaatgat			1915

&lt;210&gt; SEQ ID NO 2

&lt;211&gt; LENGTH: 535

&lt;212&gt; TYPE: PRT

&lt;213&gt; ORGANISM: Populus tremuloides Michx. (aspen)

&lt;400&gt; SEQUENCE: 2

Met Asn Pro Gln Glu Phe Ile Phe Arg Ser Lys Leu Pro Asp Ile Tyr  
 1 5 10 15

Ile Pro Lys Asn Leu Pro Leu His Ser Tyr Val Leu Glu Asn Leu Ser  
 20 25 30

Lys His Ser Ser Lys Pro Cys Leu Ile Asn Gly Ala Asn Gly Asp Val  
 35 40 45

Tyr Thr Tyr Ala Asp Val Glu Leu Thr Ala Arg Arg Val Ala Ser Gly  
 50 55 60

Leu Asn Lys Ile Gly Ile Gln Gln Gly Asp Val Ile Met Leu Phe Leu  
 65 70 75 80

Pro Ser Ser Pro Glu Phe Val Leu Ala Phe Leu Gly Ala Ser His Arg  
 85 90 95

-continued

---

Gly Ala Met Ile Thr Ala Ala Asn Pro Phe Ser Thr Pro Ala Glu Leu  
                   100                                  105                                  110

Ala Lys His Ala Lys Ala Ser Arg Ala Lys Leu Leu Ile Thr Gln Ala  
           115                                  120                                  125

Cys Tyr Tyr Glu Lys Val Lys Asp Phe Ala Arg Glu Ser Asp Val Lys  
       130                                  135                                  140

Val Met Cys Val Asp Ser Ala Pro Asp Gly Ala Ser Leu Phe Arg Ala  
   145                  150                                  155                                  160

His Thr Gln Ala Asp Glu Asn Glu Val Pro Gln Val Asp Ile Ser Pro  
                   165                                  170                                  175

Asp Asp Val Val Ala Leu Pro Tyr Ser Ser Gly Thr Thr Gly Leu Pro  
           180                                  185                                  190

Lys Gly Val Met Leu Thr His Lys Gly Leu Ile Thr Ser Val Ala Gln  
   195                                  200                                  205

Gln Val Asp Gly Asp Asn Pro Asn Leu Tyr Phe His Ser Glu Asp Val  
   210                                  215                                  220

Ile Leu Cys Val Leu Pro Met Phe His Ile Tyr Ala Leu Asn Ser Met  
   225                  230                                  235                                  240

Met Leu Cys Gly Leu Arg Val Gly Ala Ser Ile Leu Ile Met Pro Lys  
           245                                  250                                  255

Phe Glu Ile Gly Ser Leu Leu Gly Leu Ile Glu Lys Tyr Lys Val Ser  
   260                                  265                                  270

Ile Ala Pro Val Val Pro Pro Val Met Met Ala Ile Ala Lys Ser Pro  
   275                                  280                                  285

Asp Leu Asp Lys His Asp Leu Ser Ser Leu Arg Met Ile Lys Ser Gly  
   290                                  295                                  300

Gly Ala Pro Leu Gly Lys Glu Leu Glu Asp Thr Val Arg Ala Lys Phe  
   305                                  310                                  315                                  320

Pro Gln Ala Arg Leu Gly Gln Gly Tyr Gly Met Thr Glu Ala Gly Pro  
           325                                  330                                  335

Val Leu Ala Met Cys Leu Ala Phe Ala Lys Glu Pro Phe Asp Ile Lys  
   340                                  345                                  350

Pro Gly Ala Cys Gly Thr Val Val Arg Asn Ala Glu Met Lys Ile Val  
   355                                  360                                  365

Asp Pro Glu Thr Gly Val Ser Leu Pro Arg Asn Gln Pro Gly Glu Ile  
   370                                  375                                  380

Cys Ile Arg Gly Asp Gln Ile Met Lys Gly Tyr Leu Asn Asp Pro Glu  
   385                                  390                                  395                                  400

Ala Thr Ser Arg Thr Ile Asp Lys Glu Gly Trp Leu His Thr Gly Asp  
           405                                  410                                  415

Ile Gly Tyr Ile Asp Asp Asp Glu Leu Phe Ile Val Asp Arg Leu  
   420                                  425                                  430

Lys Glu Leu Ile Lys Tyr Lys Gly Phe Gln Val Ala Pro Thr Glu Leu  
   435                                  440                                  445

Glu Ala Leu Leu Ile Ala His Pro Glu Ile Ser Asp Ala Ala Val Val  
   450                                  455                                  460

Gly Leu Lys Asp Glu Asp Ala Gly Glu Val Pro Val Ala Phe Val Val  
   465                                  470                                  475                                  480

Lys Ser Glu Lys Ser Gln Ala Thr Glu Asp Glu Ile Lys Gln Tyr Ile  
           485                                  490                                  495

Ser Lys Gln Val Ile Phe Tyr Lys Arg Ile Lys Arg Val Phe Phe Ile  
   500                                  505                                  510



-continued

---

Glu Ala Ile Pro Lys Ala Pro Ser Gly Lys Ile Leu Arg Lys Asn Leu  
515 520 525

Lys Glu Lys Leu Pro Gly Ile  
530 535

<210> SEQ ID NO 3  
<211> LENGTH: 1710  
<212> TYPE: DNA  
<213> ORGANISM: Populus tremuloides Michx. (aspen)  
<220> FEATURE:  
<221> NAME/KEY: CDS  
<222> LOCATION: (1)...(1710)

<400> SEQUENCE: 3

atg atg tcc gtg gcc acg gtt gag ccc ccg aaa ccg gaa ctc tcc cct 48  
Met Met Ser Val Ala Thr Val Glu Pro Pro Lys Pro Glu Leu Ser Pro  
1 5 10 15

cca caa aac caa aac gca cca tcc tct cat gaa act gat cac att ttc 96  
Pro Gln Asn Gln Asn Ala Pro Ser Ser His Glu Thr Asp His Ile Phe  
20 25 30

aga tca aaa cta cca gac ata acc atc tcg aac gac ctc cct ctg cac 144  
Arg Ser Lys Leu Pro Asp Ile Thr Ile Ser Asn Asp Leu Pro Leu His  
35 40 45

gca tac tgc ttt gaa aac ctc tct gat ttc tca gat agg cca tgc ttg 192  
Ala Tyr Cys Phe Glu Asn Leu Ser Asp Phe Ser Asp Arg Pro Cys Leu  
50 55 60

att tca ggt tcc acg gga aaa acc tat tct ttt gcc gaa act cac ctc 240  
Ile Ser Gly Ser Thr Gly Lys Thr Tyr Ser Phe Ala Glu Thr His Leu  
65 70 75 80

ata tct cgg aag gtc gct gct ggg tta tcc aat ttg ggc atc aag aaa 288  
Ile Ser Arg Lys Val Ala Ala Gly Leu Ser Asn Leu Gly Ile Lys Lys  
85 90 95

ggc gat gta atc atg acc ctg ctc caa aac tgc cca gaa ttc gtc ttc 336  
Gly Asp Val Ile Met Thr Leu Leu Gln Asn Cys Pro Glu Phe Val Phe  
100 105 110

tcc ttc atc ggt gct tcc atg att ggt gca gtc atc acc act gcg aac 384  
Ser Phe Ile Gly Ala Ser Met Ile Gly Ala Val Ile Thr Thr Ala Asn  
115 120 125

cct ttc tac act caa agt gaa ata ttc aag caa ttc tct gct tct cgt 432  
Pro Phe Tyr Thr Gln Ser Glu Ile Phe Lys Gln Phe Ser Ala Ser Arg  
130 135 140

gcg aaa ctg att atc acc cag tct caa tat gtg aac aag cta gga gat 480  
Ala Lys Leu Ile Ile Thr Gln Ser Gln Tyr Val Asn Lys Leu Gly Asp  
145 150 155 160

agt gat tgc cat gaa aac aac caa aaa ccg ggg gaa gat ttc ata gta 528  
Ser Asp Cys His Glu Asn Asn Gln Lys Pro Gly Glu Asp Phe Ile Val  
165 170 175

atc acc att gat gac ccg cca gag aac tgt cta cat ttc aat gtg ctt 576  
Ile Thr Ile Asp Asp Pro Pro Glu Asn Cys Leu His Phe Asn Val Leu  
180 185 190

gtc gag gct agc gag agt gaa atg cca aca gtt tca atc ctt ccg gat 624  
Val Glu Ala Ser Glu Ser Glu Met Pro Thr Val Ser Ile Leu Pro Asp  
195 200 205

gat cct gtg gca tta cca ttc tct tca ggg aca aca ggg ctc cca aaa 672  
Asp Pro Val Ala Leu Pro Phe Ser Ser Gly Thr Thr Gly Leu Pro Lys  
210 215 220

gga gtg ata ctg acc cac aag agc ttg ata aca agt gtg gct caa caa 720  
Gly Val Ile Leu Thr His Lys Ser Leu Ile Thr Ser Val Ala Gln Gln  
225 230 235 240

gtt gat gga gag atc cca aat tta tac ttg aaa caa gat gac gtt gtt 768  
Val Asp Gly Glu Ile Pro Asn Leu Tyr Leu Lys Gln Asp Asp Val Val

-continued

245		250		255		
tta tgc gtt tta cct ttg ttt cac atc ttt tca ttg aac agc gtg ttg						816
Leu Cys Val Leu Pro Leu Phe His Ile Phe Ser Leu Asn Ser Val Leu	260		265		270	
tta tgc tcg ttg aga gcc ggt tct gct gtt ctt tta atg caa aag ttt						864
Leu Cys Ser Leu Arg Ala Gly Ser Ala Val Leu Leu Met Gln Lys Phe	275		280		285	
gag ata gga tca ctg cta gag ctc att cag aaa cac aat gtt tcg gtt						912
Glu Ile Gly Ser Leu Leu Glu Leu Ile Gln Lys His Asn Val Ser Val	290		295		300	
gcg gct gtg gtg cca cca ctg gtg ctg gcg ttg gcc aag aac cca ttg						960
Ala Ala Val Val Pro Pro Leu Val Leu Ala Leu Ala Lys Asn Pro Leu	305		310		315	320
gag gcg aac ttc gac ttg agt tcg atc agg gta gtc ctg tca ggg gct						1008
Glu Ala Asn Phe Asp Leu Ser Ser Ile Arg Val Val Leu Ser Gly Ala	325		330		335	
gcg cca ctg ggg aag gag ctc gag gac gcc ctc agg agc agg gtt cct						1056
Ala Pro Leu Gly Lys Glu Leu Glu Asp Ala Leu Arg Ser Arg Val Pro	340		345		350	
cag gcc atc ctg gga cag ggt tat ggg atg aca gag gcc ggg cct gtg						1104
Gln Ala Ile Leu Gly Gln Gly Tyr Gly Met Thr Glu Ala Gly Pro Val	355		360		365	
cta tca atg tgc tta gcc ttt tca aag caa cct ttc cca acc aag tct						1152
Leu Ser Met Cys Leu Ala Phe Ser Lys Gln Pro Phe Pro Thr Lys Ser	370		375		380	
ggg tcg tgt gga acg gtg gtt aga aac gca gag ctc aag gtc att gac						1200
Gly Ser Cys Gly Thr Val Val Arg Asn Ala Glu Leu Lys Val Ile Asp	385		390		395	400
cct gag acc ggt cgc tct ctt ggt tac aac caa cct ggt gaa atc tgc						1248
Pro Glu Thr Gly Arg Ser Leu Gly Tyr Asn Gln Pro Gly Glu Ile Cys	405		410		415	
atc cgt gga tcc caa atc atg aaa gga tat ttg aat gac gcg gaa gcc						1296
Ile Arg Gly Ser Gln Ile Met Lys Gly Tyr Leu Asn Asp Ala Glu Ala	420		425		430	
acg gca aac acc ata gac gtt gag ggt tgg ctc cac act gga gat ata						1344
Thr Ala Asn Thr Ile Asp Val Glu Gly Trp Leu His Thr Gly Asp Ile	435		440		445	
ggt tat gtc gac gac gac gac gag att ttc att gtt gat aga gtg aag						1392
Gly Tyr Val Asp Asp Asp Asp Glu Ile Phe Ile Val Asp Arg Val Lys	450		455		460	
gaa atc ata aaa ttc aaa ggc ttc cag gtg ccg cca gcg gag ctt gag						1440
Glu Ile Ile Lys Phe Lys Gly Phe Gln Val Pro Pro Ala Glu Leu Glu	465		470		475	480
gct ctc ctt gta aac cac cct tca att gcg gat gcg gct gtt gtt ccg						1488
Ala Leu Leu Val Asn His Pro Ser Ile Ala Asp Ala Ala Val Val Pro	485		490		495	
caa aaa gac gag gtt gct ggt gaa gtt cct gtc gcg ttt gtg gtc cgc						1536
Gln Lys Asp Glu Val Ala Gly Glu Val Pro Val Ala Phe Val Val Arg	500		505		510	
tca gat gat ctt gac ctt agt gaa gag gct gta aaa gaa tac att gca						1584
Ser Asp Asp Leu Asp Leu Ser Glu Glu Ala Val Lys Glu Tyr Ile Ala	515		520		525	
aag cag gtg gtg ttc tac aag aaa ctg cac aag gtg ttc ttc gtt cat						1632
Lys Gln Val Val Phe Tyr Lys Lys Leu His Lys Val Phe Phe Val His	530		535		540	
tct att ccc aaa tcg gct tct gga aag att cta aga aaa gac ctc aga						1680
Ser Ile Pro Lys Ser Ala Ser Gly Lys Ile Leu Arg Lys Asp Leu Arg	545		550		555	560
gcc aag ctt gcc aca gcc acc acc atg tcc						1710

-continued

---

Ala Lys Leu Ala Thr Ala Thr Thr Met Ser  
565 570

<210> SEQ ID NO 4  
 <211> LENGTH: 570  
 <212> TYPE: PRT  
 <213> ORGANISM: Populus tremuloides Michx. (aspen)

<400> SEQUENCE: 4

Met Met Ser Val Ala Thr Val Glu Pro Pro Lys Pro Glu Leu Ser Pro  
1 5 10 15

Pro Gln Asn Gln Asn Ala Pro Ser Ser His Glu Thr Asp His Ile Phe  
20 25 30

Arg Ser Lys Leu Pro Asp Ile Thr Ile Ser Asn Asp Leu Pro Leu His  
35 40 45

Ala Tyr Cys Phe Glu Asn Leu Ser Asp Phe Ser Asp Arg Pro Cys Leu  
50 55 60

Ile Ser Gly Ser Thr Gly Lys Thr Tyr Ser Phe Ala Glu Thr His Leu  
65 70 75 80

Ile Ser Arg Lys Val Ala Ala Gly Leu Ser Asn Leu Gly Ile Lys Lys  
85 90 95

Gly Asp Val Ile Met Thr Leu Leu Gln Asn Cys Pro Glu Phe Val Phe  
100 105 110

Ser Phe Ile Gly Ala Ser Met Ile Gly Ala Val Ile Thr Thr Ala Asn  
115 120 125

Pro Phe Tyr Thr Gln Ser Glu Ile Phe Lys Gln Phe Ser Ala Ser Arg  
130 135 140

Ala Lys Leu Ile Ile Thr Gln Ser Gln Tyr Val Asn Lys Leu Gly Asp  
145 150 155 160

Ser Asp Cys His Glu Asn Asn Gln Lys Pro Gly Glu Asp Phe Ile Val  
165 170 175

Ile Thr Ile Asp Asp Pro Pro Glu Asn Cys Leu His Phe Asn Val Leu  
180 185 190

Val Glu Ala Ser Glu Ser Glu Met Pro Thr Val Ser Ile Leu Pro Asp  
195 200 205

Asp Pro Val Ala Leu Pro Phe Ser Ser Gly Thr Thr Gly Leu Pro Lys  
210 215 220

Gly Val Ile Leu Thr His Lys Ser Leu Ile Thr Ser Val Ala Gln Gln  
225 230 235 240

Val Asp Gly Glu Ile Pro Asn Leu Tyr Leu Lys Gln Asp Asp Val Val  
245 250 255

Leu Cys Val Leu Pro Leu Phe His Ile Phe Ser Leu Asn Ser Val Leu  
260 265 270

Leu Cys Ser Leu Arg Ala Gly Ser Ala Val Leu Leu Met Gln Lys Phe  
275 280 285

Glu Ile Gly Ser Leu Leu Glu Leu Ile Gln Lys His Asn Val Ser Val  
290 295 300

Ala Ala Val Val Pro Pro Leu Val Leu Ala Leu Ala Lys Asn Pro Leu  
305 310 315 320

Glu Ala Asn Phe Asp Leu Ser Ser Ile Arg Val Val Leu Ser Gly Ala  
325 330 335

Ala Pro Leu Gly Lys Glu Leu Glu Asp Ala Leu Arg Ser Arg Val Pro  
340 345 350

Gln Ala Ile Leu Gly Gln Gly Tyr Gly Met Thr Glu Ala Gly Pro Val  
355 360 365

-continued

Leu Ser Met Cys Leu Ala Phe Ser Lys Gln Pro Phe Pro Thr Lys Ser  
 370 375 380  
 Gly Ser Cys Gly Thr Val Val Arg Asn Ala Glu Leu Lys Val Ile Asp  
 385 390 395 400  
 Pro Glu Thr Gly Arg Ser Leu Gly Tyr Asn Gln Pro Gly Glu Ile Cys  
 405 410 415  
 Ile Arg Gly Ser Gln Ile Met Lys Gly Tyr Leu Asn Asp Ala Glu Ala  
 420 425 430  
 Thr Ala Asn Thr Ile Asp Val Glu Gly Trp Leu His Thr Gly Asp Ile  
 435 440 445  
 Gly Tyr Val Asp Asp Asp Asp Glu Ile Phe Ile Val Asp Arg Val Lys  
 450 455 460  
 Glu Ile Ile Lys Phe Lys Gly Phe Gln Val Pro Ala Glu Leu Glu  
 465 470 475 480  
 Ala Leu Leu Val Asn His Pro Ser Ile Ala Asp Ala Ala Val Val Pro  
 485 490 495  
 Gln Lys Asp Glu Val Ala Gly Glu Val Pro Val Ala Phe Val Val Arg  
 500 505 510  
 Ser Asp Asp Leu Asp Leu Ser Glu Glu Ala Val Lys Glu Tyr Ile Ala  
 515 520 525  
 Lys Gln Val Val Phe Tyr Lys Lys Leu His Lys Val Phe Phe Val His  
 530 535 540  
 Ser Ile Pro Lys Ser Ala Ser Gly Lys Ile Leu Arg Lys Asp Leu Arg  
 545 550 555 560  
 Ala Lys Leu Ala Thr Ala Thr Thr Met Ser  
 565 570

&lt;210&gt; SEQ ID NO 5

&lt;211&gt; LENGTH: 1172

&lt;212&gt; TYPE: DNA

&lt;213&gt; ORGANISM: Populus tremuloides Michx. (aspen)

&lt;400&gt; SEQUENCE: 5

```

tgtaggattg gtggaatggg atcattccta atccccttaac gacgggtggca tgaacacaaa      60
gcaaagagaa gttagggtcac tcctccttta tatatatata tatatgcatg catgaggacc      120
atggctatga tgaagggttaa tagaggtagt tgtgattgag atatgtccag cactagtttt      180
ttgttggtgt gattttctcat gatgacgcca aaattttata tatatatata atgaataata      240
tgattgatta ttctctgtaa ttttgtgaaa tagattaataa cagctcaatg tgaggtgacc      300
agttgtcaaa tgaccactcg acttggggca tgggtgatttt tcaaatcaca actcaatttg      360
aaaactaaaa ttaaaaaaga tttagattat taaattatta ggtaattca cgggttggtc      420
aatcaattat tattaattaa aacgatagta tttttgataa ttaattaaa attttatttg      480
at ttgaaatga actcaattac atcacaaaaa acctaatcaa attaatatct tatgtgatat      540
aat ttgaaaa tataaatgat taacctttaa atctcgagtt tctcttataa aaaacacgta      600
taattgggct agatttaaca gctattattc aaactggcca ggacaattat taaaattaat      660
aattattatt ttttctaata aagcacttcc taattgtaa aatatatgtc taaacactaa      720
taataaaatt tatttgtgta tctttggcag taggtgagag gtgctgacaa ataaattagt      780
gcataaaata taatggattg gtggctctgtg aaaagacagg tggaggacaa gccacctctc      840
tcaagtcaaa aggccatttc acaaccaacc caaatgggaa cccaccaccg ttccccgcca      900
ttaaataccc taatctcacc aaccaactc cacagattct tcaccaaacg caactgattt      960

```

-continued

---

```

ttcaatcaat gttttcccta tactaccccc ccaacaactc cataataccc aatttgctct 1020
ttcaccaacc cccgctctcc gtgccagcca attctatata agcaggaatg ctctgcactc 1080
tgcttttcca ggtctcttac cataagaaaa cagagagcac ctaaaactcg ccatctctcc 1140
ctctgcatct ttgcccgcga atggacgcga ca 1172

```

```

<210> SEQ ID NO 6
<211> LENGTH: 1180
<212> TYPE: DNA
<213> ORGANISM: Populus tremuloides Michx. (aspen)

```

```

<400> SEQUENCE: 6

```

```

aagctttgag tattcatatg ggtattcatt cgaccattat ttttcaattt gtggtgtgtt 60
gatccaattt tcaacttatt tttttttcac ttatttttta ttagttattt ttatttttat 120
tattttttta aaaatttaaa aattaaatta taacattttt attttatccc tcattaacta 180
aaatagggat ggtaatagat attcatgaag ggagttatat atcaaatgat attagttaag 240
ctattttgat atttataccc tactcattac ttatggaata aaaaatttag atatttataa 300
aatatttata ggatttcagg tattcatatg aatatttatt tgattattat ttattcaaca 360
aaaaataaaa caattaatat gcatgtttga agtttatata tatattaagt taggtttaga 420
tagattttgg gtggggttaa ttaatttca taccctatct actatctatc aaataatcca 480
aataaattca cctaaattag gttgggtttg tattcatcaa gttaacatta aattgtaatt 540
ccgtaagtaa ctaacaagt acaagactt ctattttatc ttatatatta ccataaagcc 600
aactatattt cctattcttt ttcattcctt ctatcgtaat tttctgtgac ttttttattt 660
atatattaac ggtaacgaaa cacagcaata aaagttattg tgaagatat ggataattat 720
tatggtgact atgaaagagt aaatttgcca tgcactaagt tcctagtgtc atctcataaa 780
agacttgct gccacgtaag ctggttgtag tgcgtttat ttacgctgt caaccaatcg 840
ctgccaattg actcttgagg gtaggtgaga gcttcggctt tgatgggaac tgcattgaggc 900
atagggtttg gtttctttaa tgtgagatgg gcatgctttg gctcccttgc tactcaactc 960
atcttcaatt tgccagctca gctaccagtc tctcaccact agtttcacca aactttctct 1020
gctcctgat ttattacacc ttgctcgatt ggctcogtcc tcgtacacgc atccacaccg 1080
atcgatcgat tagaacata cagaattggg attggttggg tttacattct gcgtagata 1140
catctatcac agaagaaac tcccttccat ctcaggaaac 1180

```

```

<210> SEQ ID NO 7
<211> LENGTH: 12
<212> TYPE: PRT
<213> ORGANISM: Populus tremuloides Michx. (aspen)

```

```

<400> SEQUENCE: 7

```

```

Leu Pro Tyr Ser Ser Gly Thr Thr Gly Leu Pro Lys
 1             5             10

```

```

<210> SEQ ID NO 8
<211> LENGTH: 7
<212> TYPE: PRT
<213> ORGANISM: Populus tremuloides Michx. (aspen)

```

```

<400> SEQUENCE: 8

```

```

Gly Glu Ile Cys Ile Arg Gly
 1             5

```

-continued

---

```

<210> SEQ ID NO 9
<211> LENGTH: 31
<212> TYPE: DNA
<213> ORGANISM: Populus tremuloides Michx. (aspen)
<220> FEATURE:
<221> NAME/KEY: modified_base
<222> LOCATION: (11)
<223> OTHER INFORMATION: n represents inosine
<220> FEATURE:
<221> NAME/KEY: modified_base
<222> LOCATION: (14)
<223> OTHER INFORMATION: n represents inosine
<220> FEATURE:
<221> NAME/KEY: modified_base
<222> LOCATION: (17)
<223> OTHER INFORMATION: n represents inosine
<220> FEATURE:
<221> NAME/KEY: modified_base
<222> LOCATION: (20)
<223> OTHER INFORMATION: n represents inosine
<220> FEATURE:
<221> NAME/KEY: modified_base
<222> LOCATION: (23)
<223> OTHER INFORMATION: n represents inosine

<400> SEQUENCE: 9

ttggatccgg nacnacnggn ytnccnaarg g 31

```

```

<210> SEQ ID NO 10
<211> LENGTH: 28
<212> TYPE: DNA
<213> ORGANISM: Populus tremuloides Michx. (aspen)
<220> FEATURE:
<221> NAME/KEY: modified_base
<222> LOCATION: (11)
<223> OTHER INFORMATION: n represents inosine
<220> FEATURE:
<221> NAME/KEY: modified_base
<222> LOCATION: (14)
<223> OTHER INFORMATION: n represents inosine
<220> FEATURE:
<221> NAME/KEY: modified_base
<222> LOCATION: (23)
<223> OTHER INFORMATION: n represents inosine

<400> SEQUENCE: 10

ttggatccgt ngcncarcar gtngaygg 28

```

```

<210> SEQ ID NO 11
<211> LENGTH: 27
<212> TYPE: DNA
<213> ORGANISM: Populus tremuloides Michx. (aspen)
<220> FEATURE:
<221> NAME/KEY: modified_base
<222> LOCATION: (10)
<223> OTHER INFORMATION: n represents inosine
<220> FEATURE:
<221> NAME/KEY: modified_base
<222> LOCATION: (25)
<223> OTHER INFORMATION: n represents inosine

<400> SEQUENCE: 11

atgtcgaccn ckdatrcada tytncnc 27

```

```

<210> SEQ ID NO 12
<211> LENGTH: 7
<212> TYPE: PRT
<213> ORGANISM: Populus tremuloides Michx. (aspen) unknown

<400> SEQUENCE: 12

Gly Glu Ile Cys Ile Arg Gly

```

-continued

---

1	5	
<210> SEQ ID NO 13		
<211> LENGTH: 27		
<212> TYPE: DNA		
<213> ORGANISM: Populus tremuloides Michx. (aspen)		
<400> SEQUENCE: 13		
tctgtctaga tgatgctgtg gccacgg		27
<210> SEQ ID NO 14		
<211> LENGTH: 26		
<212> TYPE: DNA		
<213> ORGANISM: Populus tremuloides Michx. (aspen)		
<400> SEQUENCE: 14		
ttagatctct aggacatggt ggtggc		26
<210> SEQ ID NO 15		
<211> LENGTH: 16		
<212> TYPE: DNA		
<213> ORGANISM: Populus tremuloides Michx. (aspen)		
<400> SEQUENCE: 15		
cctttcacca accccc		16

---

We claim:

1. An isolated promoter comprising SEQ ID NO:6.
2. A polynucleotide construct comprising the promoter of claim 1 operably connected to a polynucleotide coding sequence.
3. The construct of claim 2, wherein the coding sequence encodes a p-coumarate Co-enzyme A amino acid sequence.
4. A method of expressing a polynucleotide coding sequence in the epidermis of a plant, comprising:
  - (a) introducing the DNA construct of claim 2 into a plant cell; and
  - (b) regenerating a transgenic plant from the plant cell, wherein the polynucleotide coding sequence is expressed in the epidermis of the plant.
5. The method of claim 4, wherein the polynucleotide coding sequence confers a trait selected from the group consisting of: altered flavanoid content, altered disease resistance, altered stress resistance, altered growth and combinations thereof, relative to a control plant.
6. A transgenic plant produced by the method of claim 4.

\* \* \* \* \*